

Electronic FX: Sync Strobe Flasher

\$1.95  
95P

STARLOG presents

# CINEMAGIC

THE GUIDE TO FANTASTIC FILMMAKING



Number 20

Profile:  
**Animated  
Adventure  
"Bandits"**

**NEW!**  
**Modular  
Ball & Socket  
Armature  
Parts**

**Masks & Makeups That Move!**

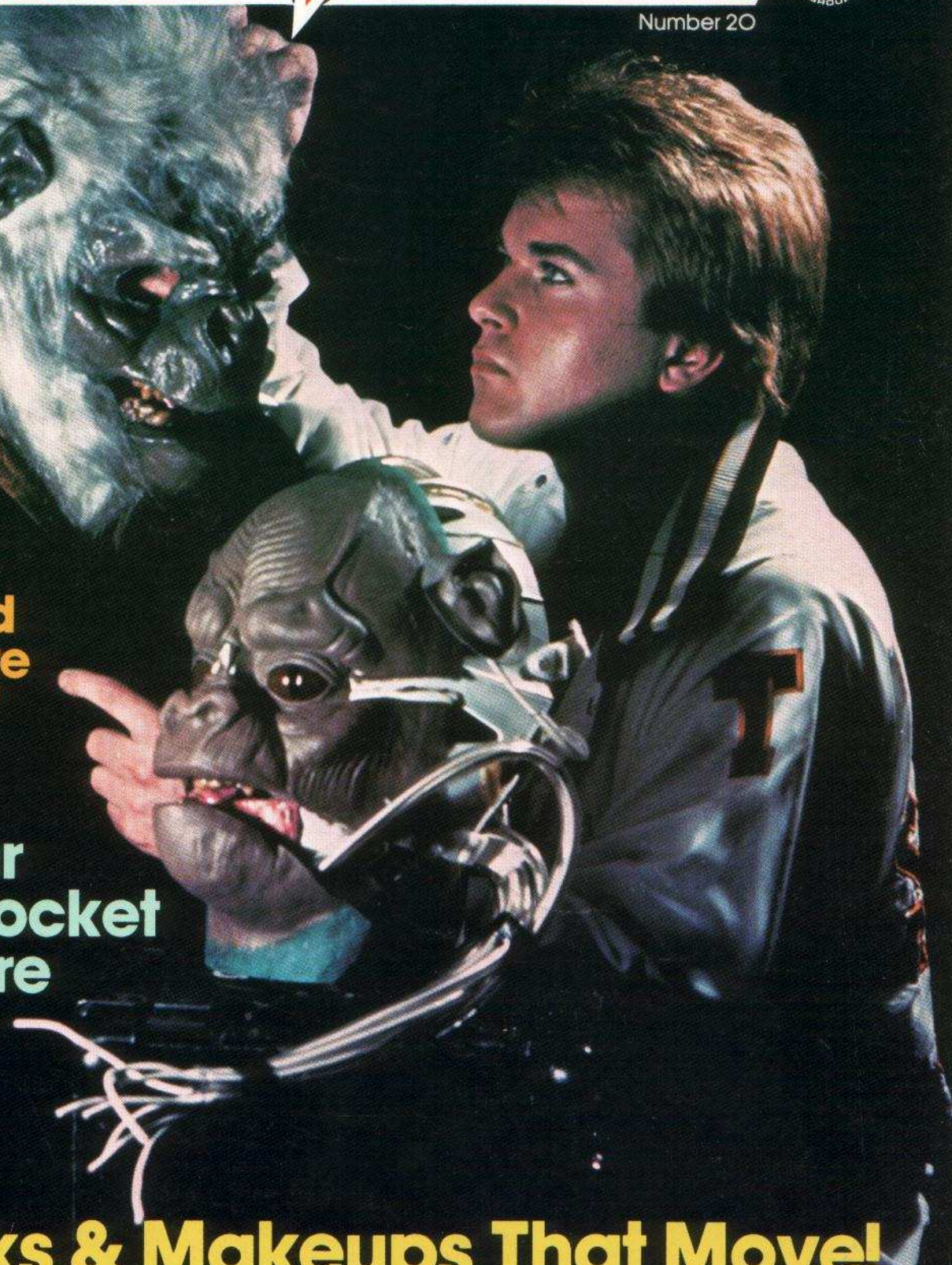



**Above:** A sample of the four different sizes of ball and socket armature parts available from animator Bill Hedge's new company, The Jointworks. The Jointworks is the first company to make precision modular ball and socket armature parts available to amateur animators on a mail order basis. See page 22.

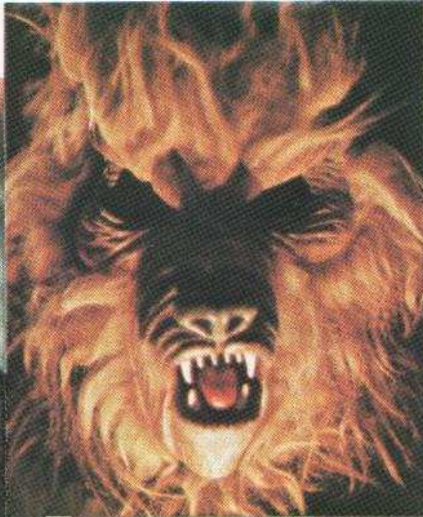

**Top of page:** A fearsome werewolf mask from Craig Robinson's film, *Lycanthropy*. **Above:** An evil alien from Centicon Productions' latest film, *Warriors of the Scarlet Dimension*. See the Producers' Bulletin Board section on page 19.

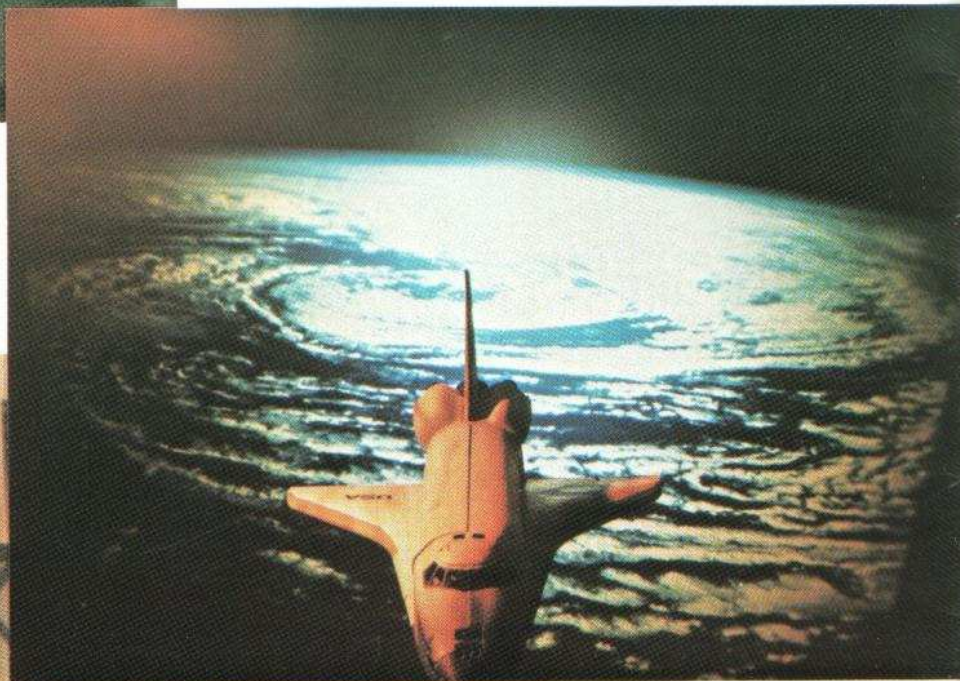

**Above:** A scene from Atlantic Pictures' latest production, *Flight to Eternity*. **Left:** A behind-the-scenes shot of the Atlantic Pictures effects crew in action. The effects in *Flight to Eternity* also feature a full size shuttle cockpit set, astronaut flight suits and other miniatures. See the Producer's Bulletin Board entry about *Flight to Eternity* on page 20.



# CONTENTS

Issue #20

**Editor's  
Bench** \_\_\_\_\_ **4**  
**Profile** \_\_\_\_\_ **6**

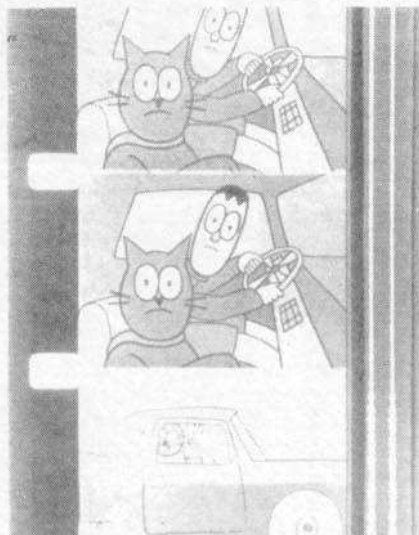

Joey Ahlbum talks about his CINE-MAGIC/SVA award winning animated adventure, *Bandits*. By John Clayton.

**Filmmakers'  
Forum** \_\_\_\_\_ **12**

A regular department devoted to readers' comments and correspondence about fantasy filmmaking.

**Electronic  
FX** \_\_\_\_\_ **14**

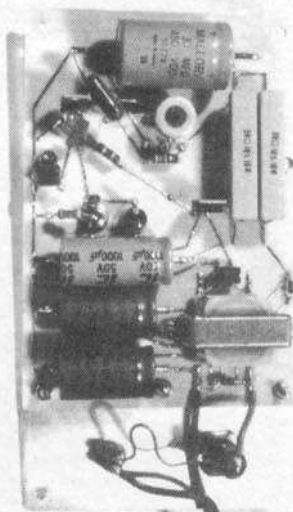

Electronic Special Effects columnist Chris E. Stevens shows you how to build a movie sync strobe unit.

**Producers'  
Bulletin  
Board** \_\_\_\_\_ **19**

Latest news of our readers' productions.

**Ball & Socket  
Parts** \_\_\_\_\_ **22**

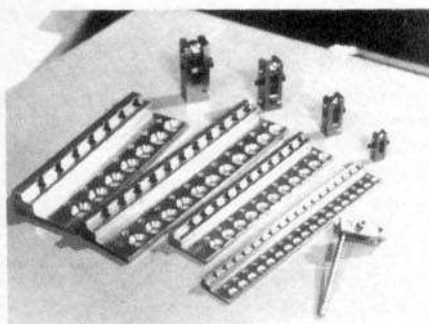

Animator Bill Hedge's new company, The Jointworks, offers modular ball & socket armature parts to amateur animators. By Nicholas Seldon.

**Grip Kit** \_\_\_\_\_ **24**



Useful accessories for filmmakers.

**Books** \_\_\_\_\_ **26**

Books for filmmakers—valuable sources of information and technique for the filmmaker.

**Cinemagic  
Market-  
Place** \_\_\_\_\_ **27**

Classified advertising and announcements.

**Dream  
Screen** \_\_\_\_\_ **28**



An inexpensive technique for creating dream sequences for fantasy films. By Jack Imes, Jr.

**Masks That  
Move** \_\_\_\_\_ **30**



Special effects artist John Dods shows you how fellow makeup artist Arnold Gargiulo creates articulated full head masks and bladder effects.



Issue #20

**Publishers**

Norman Jacobs/Kerry O'Quinn

**Associate Publisher**

Rita Eisenstein

**Circulation Director**

Richard Browne

**Editor**

David Hutchison

**Art Director**

W.R. Mohalley

**Managing Editor**

John Clayton

**Associate Art Director**

Neal Holmes

**Senior Designer**

Denise Lewis

**Designer**

Daniel Abello

**Editorial Contributors**

Joey Ahlbum

John Dods

Bill Hedge

Jack Imes, Jr.

Chris E. Stevens

**Production Assistants**

Richard Cebek

Eileen Dempsey

Norma Garcia

Mary Osorio

Andea Passes

**Financial Manager**

Joan Baetz

**Founder of CINEMAGIC**

Don Dohler

**Published by**

STARLOG PRESS, INC.

475 Park Ave. South

New York, NY 10016

Advertising Information: Rita Eisenstein  
(212) 689-2830

**About the cover:** Makeup effects artist Arnold Gargiulo poses with two of his cable-controlled, articulated full head masks. Fellow effects artist John Dods reveals Arnold's techniques for creating masks that move and bladder effects in this issue's cover story. See page 30. Cover photo by John Dods.

**Editor's**

# BENCH

## SURVIVAL!

**W**hen *Super 8 Filmmaker* ceased publication last year, it left CINEMAGIC, for all practical purposes, alone in the field. It seems there are fewer and fewer Super-8 and 16mm fantasy filmmakers every year. Perhaps we have lost some of them to video and maybe we have even lost a few to video and computer games. In any case, the interest and commitment to fantasy image making seems to be at an all time low.

It's true that fantasy filmmaking is an expensive and time consuming activity. And that those who stay with it, even in times of economic difficulty, are the very few truly dedicated, hardy souls who are hooked on the power of the medium. For with just a camera, film and a lot of imagination, you Cinemagician's have the power to make people see and feel what exists only in your mind. You can make your dreams real enough for other people to experience them.

Probably a good deal of video's appeal rests in the pocketbook. Once the initial expense for camera and recorder is out of the way, your only expense is video tape. But the whole system seems to be geared against the fantasy image maker, since the possibilities of frame-by-frame manipulation are closed to the video user. At this point in time, video is still best suited for people making "home movies," as opposed to the readers of CINEMAGIC who are interested in filmmaking.

Nonetheless, the Fifth Annual CINEMAGIC/SVA Short Film Search will again have a video category. Last year, there was very little interest shown and I will not be surprised if that continues to be the situation for some years. But video will survive and eventually come into its own.

One of the ways that filmmakers survive is by getting their work *seen*. The publishers of CINEMAGIC together with the film department of the School of Visual Arts in New York City are trying to go a step further with the problems of filmmakers. This year in addition to the screening of the winners at the awards ceremony, we hope to get the films seen on television as well, either in a syndication situation or through cable television. We hope to have something worked out by this fall and we will, of course, keep you informed through the pages of CINEMAGIC.

A filmmaker needs exposure in order to survive. His work must be seen as widely as possible. He needs to build an audience . . . ultimately to find people who will *pay* to see his work. CINEMAGIC is working to help you get your imagination on film . . . and to get your film seen. It's a question of survival . . . yours . . . and ours.

—David Hutchison

P.S. We have already received a few requests for 1983 entry forms. They will not be ready until June, however. For your copy of the 1983 rules and an official entry form, send a stamped, self-addressed #10 envelope (the one that is wider than the letter size) to: CINEMAGIC/SVA Short Film Search, Contest Rules, 475 Park Avenue South, New York, NY 10016.

CINEMAGIC is published bi-monthly by STARLOG PRESS, INC. 475 Park Avenue South, New York, NY 10016. This is issue #20 (Volume 4, No. 2). Content is © 1983 by STARLOG PRESS, INC. All rights reserved. Reprint or reproduction of any material in part or in whole without written permission from the publishers is strictly forbidden. CINEMAGIC accepts no responsibility for unsolicited manuscripts, photos, art or other material, but if freelance submittals are accompanied by a self-addressed, stamped envelope, they will be considered and, if necessary, returned. Products advertised are not necessarily endorsed by CINEMAGIC, and any views expressed in editorial copy are not necessarily those of CINEMAGIC. Subscription rates: \$9.98 for one year (six issues) delivered in the U.S., Canada and Mexico, foreign subscription \$12.98 in U.S. funds only. **New Subscriptions:** send directly to CINEMAGIC, c/o STARLOG PRESS, INC., 475 Park Avenue South, New York, NY 10016. Notification of **change of address** or **renewals** send to CINEMAGIC, Subscription Dept. P.O. Box 142, Mt. Morris, IL 61054-0142. **Postmaster:** Send form 3579 to CINEMAGIC, P.O. Box 142, Mt. Morris, IL. 61054. Application to mail second class is pending at New York, NY and other locations. Printed in U.S.A.

# WORLDS OF IMAGINATION

From  
**STARLOG PRESS**

Travel through a universe of wonder, laughs and chills with these marvelous STARLOG magazines!

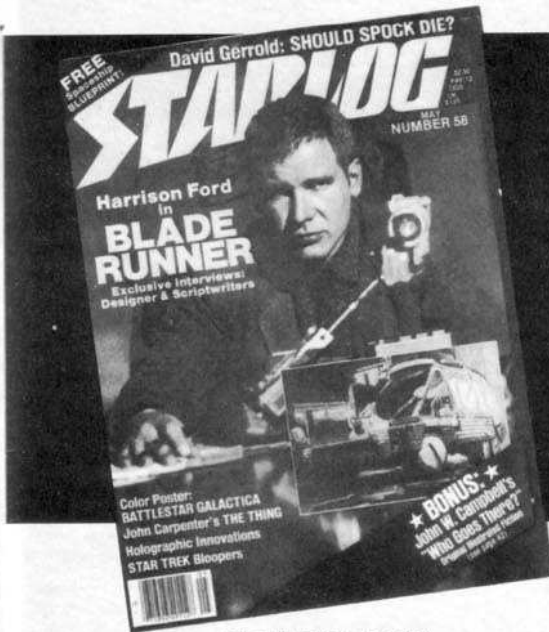

## STARLOG—

The most popular science fiction magazine in our solar system, bringing you all the latest in SF film, television and fact!

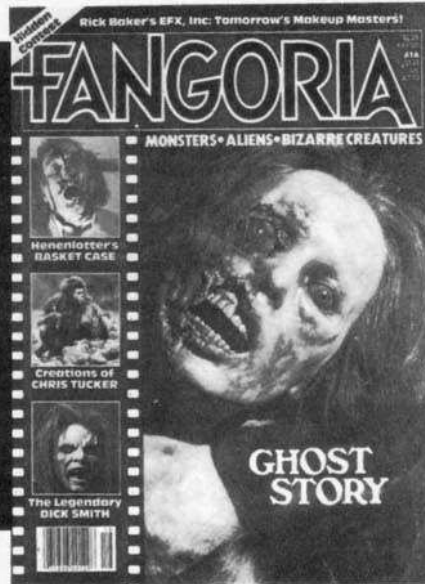

## FANGORIA—

The magazine of motion picture thrills, chills and horror, for all you brave souls with a taste for terror!



## COMICS SCENE—

The first totally professional, full-color newsstand magazine covering every facet of the world of comics.

**Explore the outer reaches of fun & imagination!**

**Look for these exciting publications  
 at your local newsstand—or subscribe today!**

Mail to: STARLOG PRESS, 475 Park Avenue South, New York, New York, 10016

— STARLOG \$23.99  
 (12 issues/year)  
 Foreign: \$32.99

— FANGORIA \$13.98  
 (8 issues/year)  
 Foreign: \$19.98

— COMICS SCENE \$11.98  
 (6 issues/year)  
 Foreign: \$16.48

Allow 7 to 9 weeks for first delivery. Foreign subscriptions, U.S. funds only.

Enclosed: \_\_\_\_\_

NAME \_\_\_\_\_

ADDRESS \_\_\_\_\_

CITY \_\_\_\_\_ STATE \_\_\_\_\_ ZIP \_\_\_\_\_

# PROFILE

## Joey Ahlbum: Personal Vision

By John Clayton

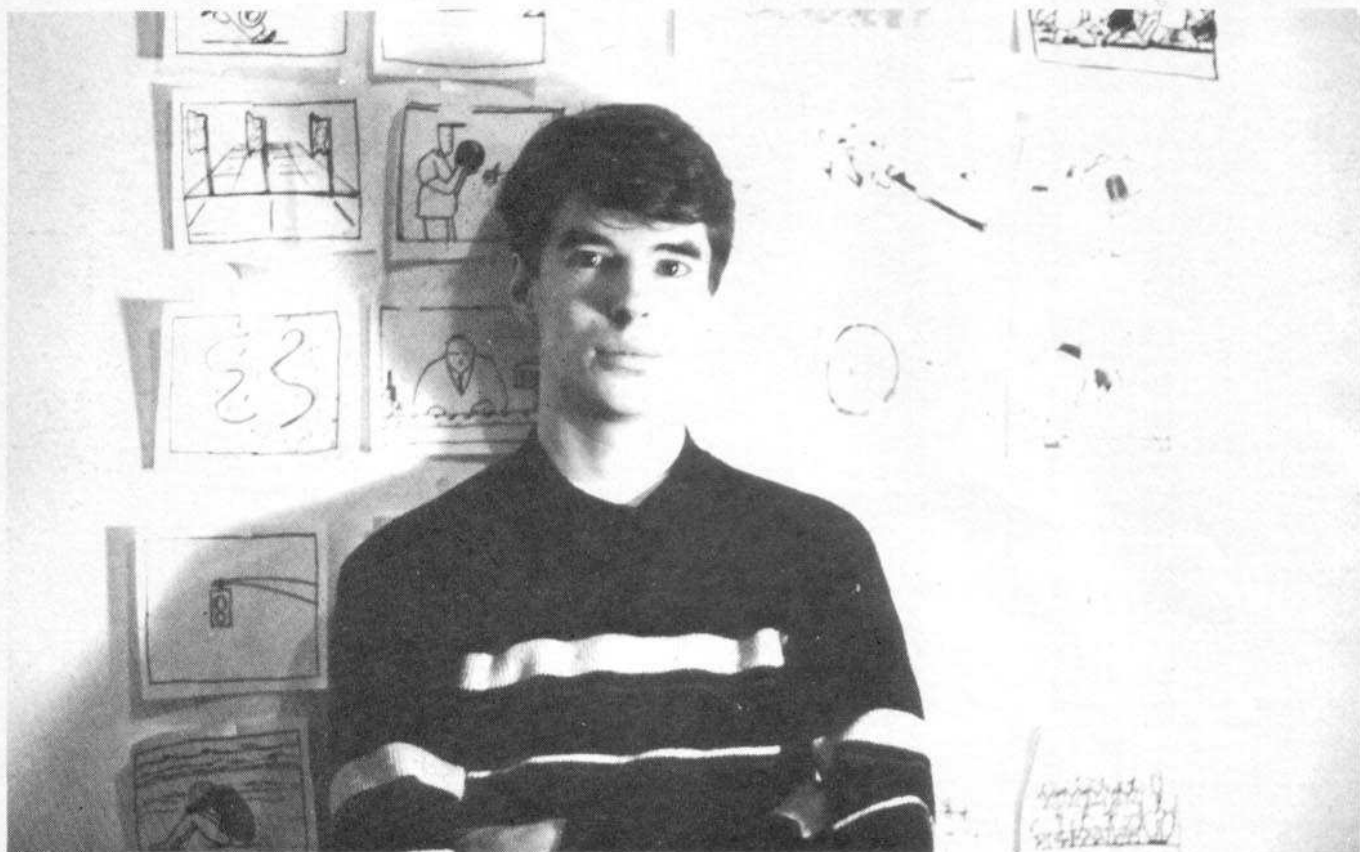

Joey Ahlbum, whose film *Bandits* was a winner in the 1982 CINEMAGIC/SVA Short Film Search, poses in front of the storyboards of his current film project, *Parade*.

**A**nimators are gifted with the rare talent of being able to create a seemingly living fantasy world entirely from their own imagination that other people can see. It's like being able to show your dreams to your friends. Unfortunately, there was only one cel animated film entered in last year's CINEMAGIC/SVA Short Film Search, but happily it was more than worthy enough to be assured of a spot in the proverbial winner's circle. We were disappointed that there was such a small response on the part of cel animators to a film contest jointly sponsored by CINEMAGIC, whose slogan is "The Guide to Fantastic Filmmaking," and The School of Visual Arts, which is one of the most important training grounds for artists and illustrators (potential cel animators) in America today. We hope to see more cel animation in future CINEMAGIC/SVA contests.

We were very happy, though, about the

one cel animated film entry that we did receive. Joey Ahlbum's *Bandits* provided some of the most entertaining moments of the evening at last year's Awards Screening. It also helped round out the show by adding variety to what was otherwise an all live-action show with some stop-motion effects sequences thrown in for good measure.

"I've been an animator for about eight years," Joey begins. "I started making animated films even before I was in high school. My first films were shot on a Super-8 camera that didn't even have single frame or reflex viewing. I started by doing cut-out animation and experimenting with clay animation. It was enough of a beginning to spark my enthusiasm, though, because I saw that despite the limitations of my equipment I was still able to make things move and appear to come alive, which I had wanted to do for a very long time. Soon afterward, I got a

Super-8 camera that could do single frame and could be focused through the lens. Before I had a single frame camera I had to animate by touching the shutter button as lightly and quickly as possible.

"I made lots of Super-8 films in the beginning, two of which I still think are good films," Joey continues. "One was a study in animation cycles that I call *Skaters*. It's basically animated ice skaters doing figure eights and ovals with the figure eights and ovals as the cycles. The motion in *Skaters* is very fluid and I'm happy with the way the film seems to flow through the use of animation cycles. *Skaters* is about three minutes long.

"The other Super-8 film that I'm still proud of is called *Fred Kid Freight Company*. That film is an adventure about a guy who owns his own freight company and who receives an order to deliver a load of gold coins. Along the way he's ambushed by thieves and he has to round up

all the thieves as well as deliver the coins. *Fred Kid Freight Company* is also about three minutes long."

## Mystery Movies

"I graduated to making 16mm films when I went to study at the School of Visual Arts after high school. I made three 16mm films at the School of Visual Arts: *Minute of Mystery*, *Three Step*, and *Bandits*. *Minute of Mystery* as the title implies, is a one minute film with a detective story plot line. *Minute of Mystery* really isn't typical cel animation. I started out trying to make a cel animated film but after shooting a test I decided I didn't like the way painted cels looked for the particular mood I was trying to capture. I felt that painting the cels with cel vinyl in standard fashion produced colors that were too flat for my subject matter. I wound up throwing away the cels I had painted, but I still had the entire film inked on cels. I ended up doing the coloring on paper with crayons underneath the inked cels. Where I needed to do a hold, I cut out the shape on colored paper and glued it to the cel. So, even though *Minute of Mystery* is inked on cels, it doesn't look like a typical cel animated film.

"*Minute of Mystery* is about a detective who solves a crime that's been committed in only one minute. It's really a flow of consciousness film. Everything flows together as if you were just thinking of it off of the top of your head. Even the most absurd ideas seem natural because of the way they just flow out of the earlier ideas that spawned them. The soundtrack to *Minute of Mystery* is the "Minute Waltz" by Chopin. It's a public domain score because it's such an old piece of music and I recorded a friend playing it on the piano, so there's no problem with the sync rights. *Minute of Mystery* has been seen on the HBO cable network.

**Below:** A scene from *Bandits* shows Super Sam and Spot on horseback in hot pursuit of the bank robbers.

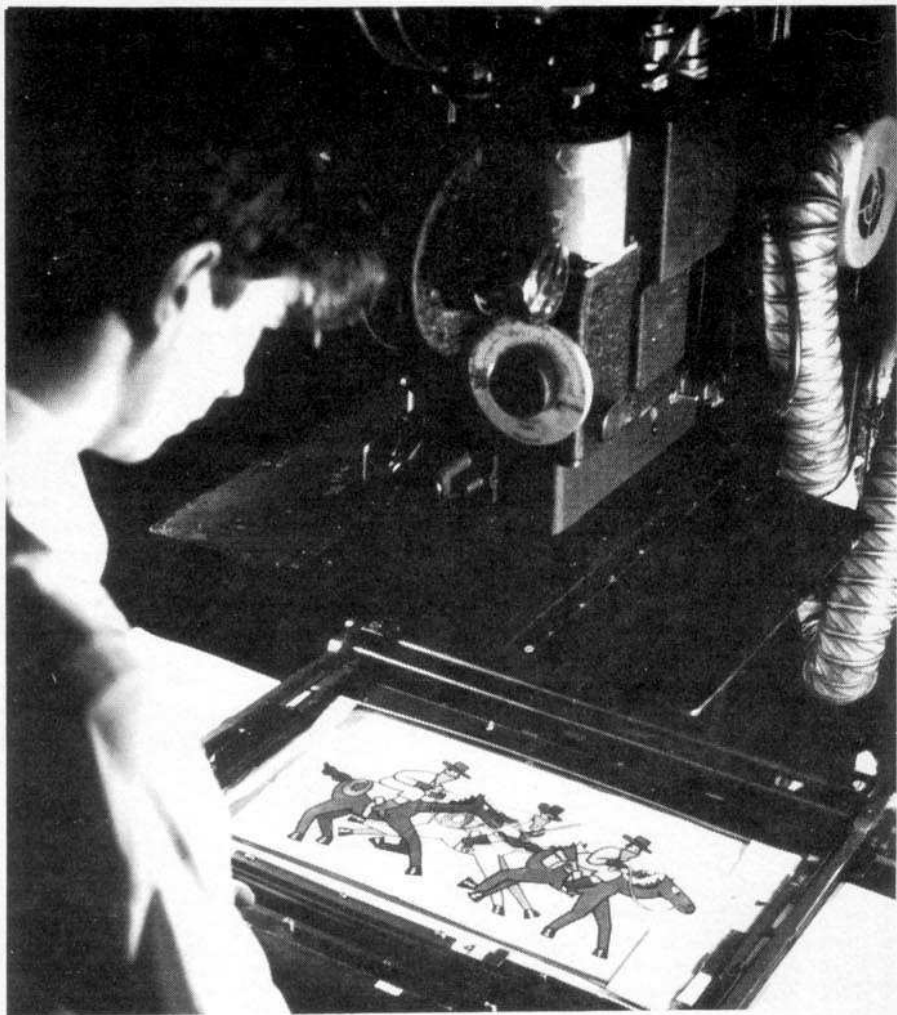

Joey animates the horse chase scene from *Bandits* on the Oxberry animation stand at the School of Visual Arts. He spent about six months making all the cels for the seven minute film. Much of the animation was lip sync dialog, which was especially time consuming to shoot because Joey animated the characters acting out their lines instead of just moving their mouths on a cel overlay. "It's harder to animate all of the business you bring into a scene," Joey says, "but it's well worth it because the results are more pleasing."

## BANDITS

"Of the other two films I did at School of Visual Arts, *Three Step* and *Bandits*, *Bandits* was by far the bigger and more ambitious film" Joey discloses. "I was very happy that *Bandits* was a winner in the CINEMAGIC/SVA Short Film Search.

"It took me two years to make *Bandits*," Joey reveals. "I had been drawing the main characters, Super Sam and Spot, since before high school as a cartoon strip and I had always wanted to make an animated film featuring these characters. I used to mail each installment of the strip to my friends and relatives and I thought it would be great to carry the adventures of Super Sam and Spot a step further by making a short film in which the characters would actually move and speak."

Super Sam is a caped hero detective who wages a ceaseless crusade for justice with the help of his loyal and talented sidekick and dog, Spot. In *Bandits*, they're after horse-riding, masked outlaws committing a string of bank robberies in modern-day New York City. This is clearly a job beyond the capabilities of average law enforcement officers. Super Sam and Spot have been called onto the case.

"Of course the first step in making *Bandits*, as with any lip sync animated film, was to write and record the dialog," Joey reflects. "Since I had been drawing Super Sam and Spot adventures as cartoon strips for years, it didn't take long to write the dialog—especially since *Bandits* is only seven minutes long. The next step was to get some people together to play the voices of the characters. Of course, I couldn't afford to hire professional actors, but I managed to find the right people (who were willing to work for free) for all of the parts. The guy who played the voice of the main bandit was very adept at doing many different styles of voices, and I though he was very talented. I played the voice of Super Sam myself and a friend played the voice of Spot. We recorded the dialog track at a professional recording studio in New York City. It was one of the few things in the production of *Bandits*—beside film and processing—that actually cost money.

"After I had the dialog track recorded, it didn't take long to break it down onto bar sheets," Joey remembers. "*Bandits* was my first experience with animating lip sync dialog, so I had to learn by doing. It



## SUBSCRIBE TO



If you are a young filmmaker with a special interest in science fiction, special effects and the limitless magic of the cinema...

### THIS IS YOUR MAGAZINE

#### CINEMAGIC WILL FEATURE:

How to produce professional titles that move, change color, melt, sparkle, burst into flames, zoom into space... all for a few bucks!

Tired of square screens? Learn about inexpensive lenses and devices to make your picture W-I-D-E-S-C-R-E-E-N. Breakaway props for realistic fight scenes.

Animation on your homemade stand. Build your own robots with electronic light effects.

Make your own foam latex animation models, molds and armatures... and make them come alive! Glass paintings, matte box effects, split screens.

Reviews of new equipment; lenses and optical gadgets for creating special effects! Readers' forum—letters and questions exchanging techniques and production secrets! Step-by-step illustrated articles detailing methods you can use to create visual effects, makeup and sound FX.

#### CINEMAGIC

O'Quinn Studios, Inc.  
475 Park Avenue South, New York, NY 10016

#### SUBSCRIPTION

- One year (6 issues) \$9.98 (U.S. and Canada)
- One year foreign surface \$14.48

Enclosed, \$  
Send cash, check, or money order drawn to O'Quinn Studios, Inc.

NAME \_\_\_\_\_

ADDRESS \_\_\_\_\_

CITY \_\_\_\_\_

STATE \_\_\_\_\_

ZIP \_\_\_\_\_

took a long time to figure out all of the animation for the lip sync scenes, because I wanted the characters to act out what they were saying and not just have them move their mouths in sync with the dialog. Some of the lip sync scenes in *Bandits* are shot on one's, the rest of the film is shot on two's. During my early pencil tests, I tried using the animation guides that show you each mouth shape for all the different vowels and consonants, but it didn't look right. For example, I'd shoot a frame showing the character's mouth opened very wide to make an "E" sound then go right to a tiny mouth shape for an "O" sound, and I found that it looked ridiculous because I wasn't considering the whole word or the fact that your mouth doesn't stretch out as much for some words as it does for others. It was very challenging for me and it was a very valuable learning experience.

"Of course for a few scenes I did just put a close-up of the character's head in the frame and did the mouth movements on a cel overlay, but that's the exception rather than the rule of the way I shot the lip sync dialog for *Bandits*. For example, there's a scene in which Spot's talking on the telephone in the car, and there's a lot of action going on while he's talking. He rolls and nods his head, he moves his eyes and blinks, he acts out what he's saying. It's harder to figure out how to animate all of the business you bring into a scene, but it's well worth it because the results are so much more pleasing.

"The next step after recording the dialog was to storyboard the film," Joey remembers. "It didn't take long to storyboard *Bandits*, I'd just think about how I wanted to animate it and write little notes to myself. What did take a long time was doing the layouts, which are like storyboards except that they're the actual frame size. It's during the layout stage that you figure out all of the key animation positions. I spent about three or four months doing the layouts. It's ultimately a great help to have carefully prepared layouts because it makes your animation go much faster.

"The hardest part of making *Bandits* was actually shooting all of the animation," Joey admits. "By the time you're ready to animate you've already prepared most of the artwork and you've taken the time to make sure that the artwork is perfect. Unfortunately, it's possible that you'll never shoot the artwork perfectly. There's always the possibility of making human errors during the animation process. Once you've shot a bad frame you're stuck with it because you can't erase it, unless the error is so gross that you can't live with it, in which case you have to reshoot the entire scene and scrap hours of work.

"I had actually only finished making about half of the cels when I began shooting *Bandits*," Joey reveals. "I spent between four and six months making the cels. About halfway through shooting the film, all the cels were completed. I shot the

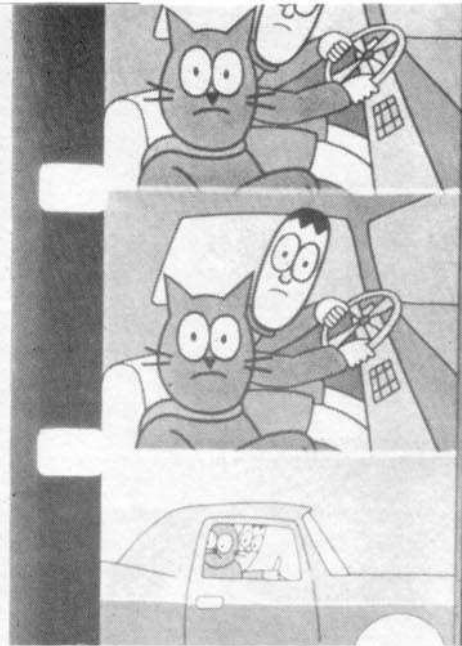

Super Sam and Spot in their highly stylized car. Joey had been drawing these caped crusaders for justice as a cartoon strip for over ten years before he brought them to life in his animated adventure, *Bandits*.

film on the 16mm Oxberry at the School of Visual Arts. I found that the best time to shoot was at night when no one else wanted to schedule time on the Oxberry. I discovered that actually shooting the animation took hours upon hours and went slower than I had expected. I developed a schedule which enabled me to work from 10 o'clock at night to 10 o'clock in the morning, Friday through Sunday. During the rest of the week I worked on making more cels, until they were finished. I shot one hundred foot loads at a time in the Oxberry camera. If I didn't finish the roll I had to rewind the film out of the camera so someone else could use the stand and reload it when it came time to shoot again. One of the great things about an Oxberry is its accuracy. You can land on any given frame, and if you've punched a hole in the head of the film you can go back and land on that same frame of film if you have to. During the production of *Bandits* I had to take advantage of this feature."

## MUSIC

One of the best elements of *Bandits* is its musical score. The music is very exciting and accents the wonderfully done animation perfectly. It helps set and maintain the mood of the film with its upbeat and very full jazz brass section. The music is an original score, so there are no legal entanglements with sync rights, as is all too often the problem with many otherwise marketable student and amateur films.

"I've always been very conscious about having a musical soundtrack that is, if not original to the film, at least in the public domain," Joey continues. "I want my films to be free of any legal problems so I can market them wherever possible. I've had both *Minute of Mystery* and *Bandits* shown on the HBO cable network. If these films had used someone else's copyrighted music, this would not have been possible.



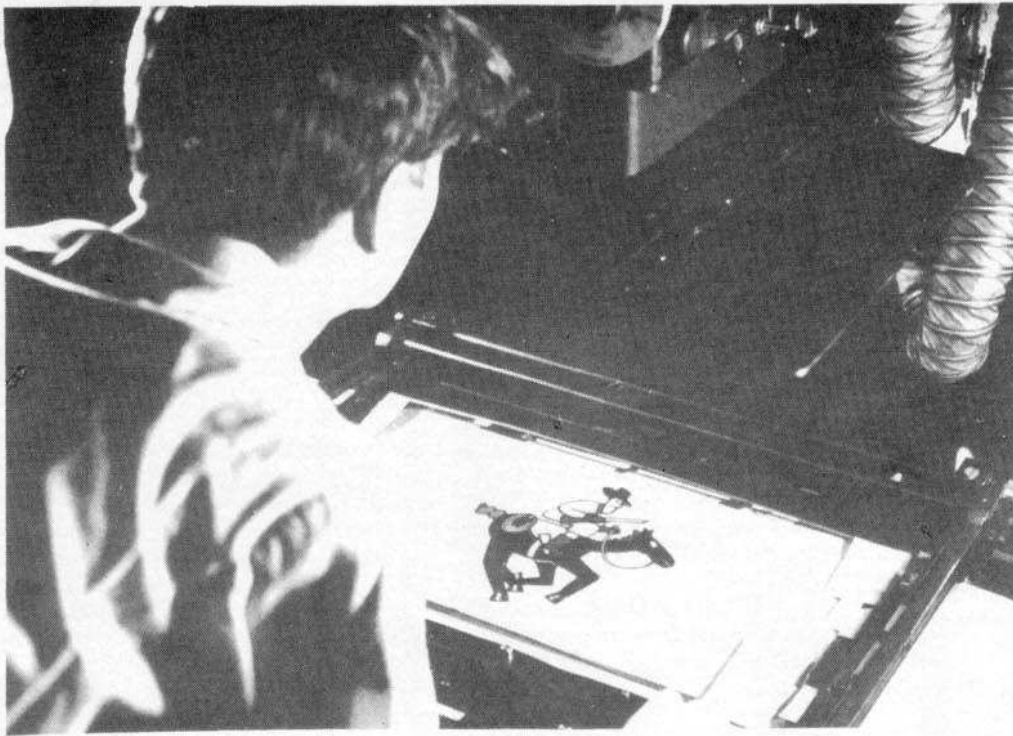

**Left:** Joey animates the leader of the thieves for a scene in *Bandits* on the Oxberry animation stand at the School of Visual Arts. Joey set up a shooting schedule at SVA that allowed him to shoot from 10 o'clock at night to 10 o'clock in the morning, Friday through Sunday. The rest of the week he worked on making more cels for the film. The Film Department at the School of Visual Arts, headed by Charles Hirsch, has helped Joey continue his work in the animation field by allowing him continued access to the Oxberry stand for non-commercial work. Of course, he has to schedule time that no one else wants and pay for all of his own materials. "I'm very grateful to the School of Visual Arts for all of the encouragement that they've given me," Joey says.

"The music for *Bandits* was written especially for the film by a very talented composer name Artie Sweet. At the time Artie was studying film composing under Jacob Stern at the Mannes College of Music and Jacob Stern had a deal where filmmakers could meet with his class and get one of his students to compose a musical soundtrack in exchange for credit on the film. Artie Sweet worked very closely with me in giving me the kind of sound I wanted for the music. By this time, of course, *Bandits* was finished and cut together except for the musical soundtrack. Artie came and saw the film and took notes and did timings with a stop watch. Then he wrote the music and the charts for all the different musicians, and got the musicians together for the recording session. We recorded the music at a studio at the Mannes College of Music and I only had to pay the recording engineer. All of the musicians were students at the

Mannes College of Music—there were about 20 of them—so I got them all for free. I was quite amazed at the level of talent of the musicians. They had never played together before and they didn't know anything about the music that Artie had written or anything about my film. Artie just got them all together one afternoon over a Memorial Day weekend, handed them their charts and they played as he conducted—and it sounded as if they had rehearsed many times.

"We didn't have the facilities to project the film during the recording session so Artie could conduct and record in sync to the film—as is done on professional soundtrack recordings—but it didn't matter. Artie just relied on the stop watch timings he had taken and I edited the music into the soundtrack at the predetermined points. I wasn't concerned about getting frame-for-frame accuracy on syncing the music. It came out perfectly. Because of

all of the work that Artie did and because I was so happy with the results he achieved with the music, I've struck a deal with him that offers him a percentage of all of the profits that *Bandits* makes.

## PRODUCING

"*Bandits* will make a profit because cable TV companies are renting it for air play," Joey confides. "But it would have been nearly impossible to make an animated short film like *Bandits* professionally and be able to make a profit. I'll only be able to make a profit on *Bandits* because it was a student production and I didn't have to pay all the people involved. Since most people rendered their services for free or for academic credit [or for art's sake], *Bandits* only cost about \$1,500 to make. Of course I put in countless hours without making any money myself, and you can't go on doing that after you leave school. You've got to earn a living at your

Spot swings into action to stop the bank robbers in a scene from *Bandits*.

Super Sam climbs up on the roof of a skyscraper in pursuit of an escaping thief.

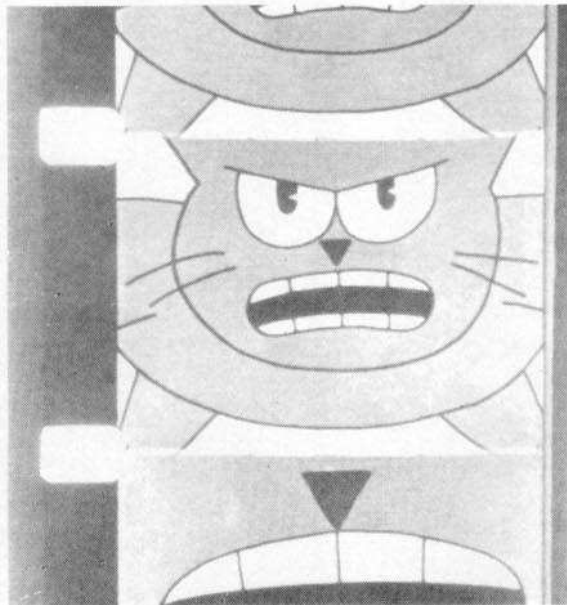

ART: JOEY ANGLIM

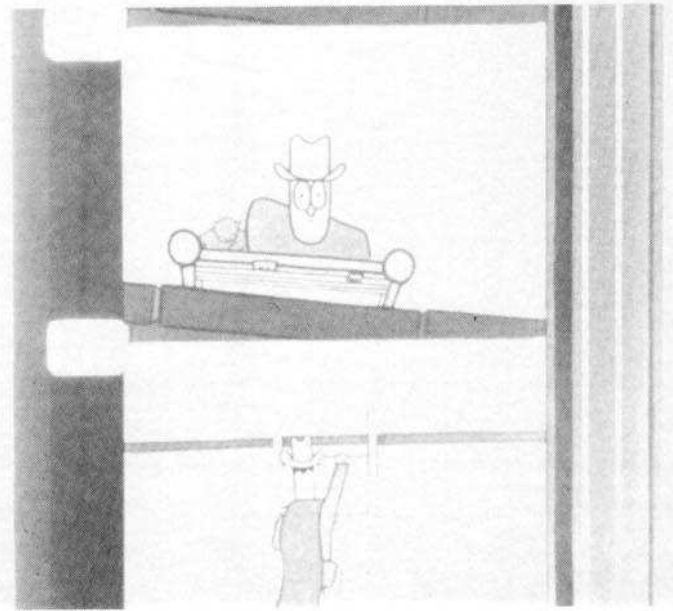



FEATURING OUR EXCLUSIVE  
MODULAR BALL & SOCKET  
JOINTING SYSTEMS FOR  
STOP-MOTION ANIMATION  
PUPPETS AND SPECIAL  
EFFECTS.

ALL PARTS ARE PRECISION  
MACHINED FROM HIGH  
QUALITY STEEL.

UNITS ARE AVAILABLE IN  
1/4", 3/8", 1/2", 5/8" BALL  
SIZES, WITH SINGLE OR  
DOUBLE BALL SOCKET  
CONFIGURATIONS.

SINGLE BALL BLOCK...

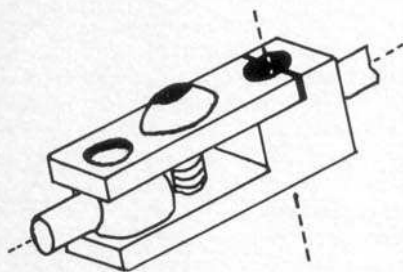

FOR AN ILLUSTRATED  
DESIGN GUIDE & CATALOG,  
SEND \$2.00 TO,

THE JOINTWORKS  
13450 MAXELLA G185-424C  
MARINA DEL REY, CA. 90291

THE JOINTWORKS IS THE  
HOLLYWOOD SOURCE FOR  
YOUR SPECIAL EFFECTS  
SUPPLY NEEDS.

© 1983 W. J. HEDGE

craft. I deeply appreciate all of the time and talent that other people donated to the making of *Bandits*. The costs of producing professional animation are prohibitive because of all the time and painstaking labor involved. That's a problem that I'm looking for a solution to and I haven't been able to find one yet. Finding funding for animation is very difficult. I'd love to do a series of Super Sam and Spot shorts, but working out all of the details of producing such a series professionally is extremely difficult.

"Working on *Bandits* got to be quite a grind towards the end because I was running out of time," Joey admits. "I wanted to have it finished in time to show at the End of Year Show at the School of Visual Arts, two years ago. It was very important for me to show people what I had been working on for the previous two years."

### FREELANCE

Since graduating from the School of Visual Arts two years ago, Joey Ahlbum has been working as a freelance professional animator.

"I did a 90 second animated title sequence for an independent film called *Wild Style* that should be released shortly," Joey reveals. "The film is being produced by Charlie Ahearn and the animation was shot in his studio because he has his own stand. I worked with a graffiti artist who calls himself Zephyr (his real name is Andrew Witten) on that sequence.

"I also did a segment of an animated show for HBO called *Brain Games* which is being directed by Eli Noyes. I was able to use Eli's stand for that job. *Brain Games* is going to be a half-hour show entirely made up of animation. It's the first time

that HBO has commissioned new animation instead of just renting existing animation. My segment is based on an old kid's game called "Droodles," in which you're given an abstraction of a drawing and you try to figure out what it is. When the whole drawing is revealed you can see quite clearly what it was all the time. The entire show is made up of games that the audience can play while the show is going on. The producers of *Brain Games* had seen *Bandits* and some of my other films and they liked my style, so they came to me with the script for the "Droodles" segment.

"As a freelance animator I can do all of my artwork at home," Joey explains. "The only other facility I need is access to an animation stand. Most of time the people who have hired me had a stand I could use. The School of Visual Arts has been generous in allowing me continued access to their Oxberry stand for pencil tests when no one else is using it. They realize I'm not making much money off of pencil tests and they have provided an atmosphere of encouragement that has helped me immensely in my continued work in the field of animation. I would like to get to the point of being able to rent an animation stand whenever I need to, but that can run into real money. I've also worked as a rotoscope artist on *The Great Space Coaster* and with Peter Wallach on a film for the Scott Newman Foundation called *Doing What the Crowd Does*. *Doing What the Crowd Does* is for distribution to schools and it tries to teach kids to resist peer pressure, especially about taking drugs.

"Working with Peter Wallach has helped me acquire a deeper appreciation

**Below:** Another frame blow-up of the horse chase sequence in *Bandits*. Joey feels that cel animation is much easier to work in than stop-motion and he prefers cel animation because he feels the animator has more control. "Trying to get a team of horses to move in stop-motion is enough to drive you insane," Joey says.

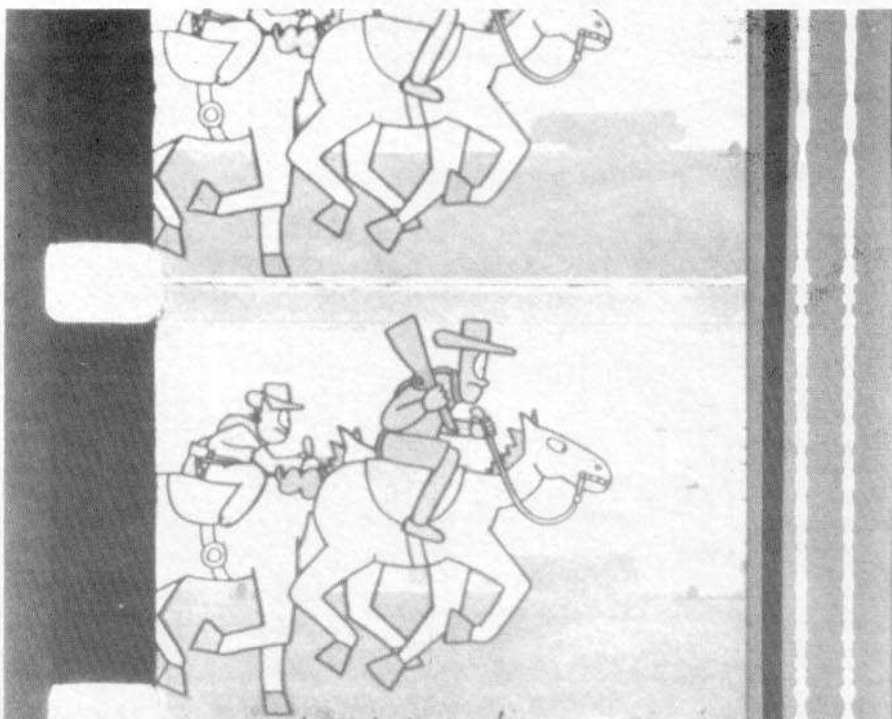

ART: JOEY AHLBUM



# Filmmakers' FORUM

A regular department devoted to readers' comments about filmmaking, their problems and solutions.

## Weathering Models

... Here's a hint for all spaceship modelmakers concerning weathering. Instead of using the conventional air brush method, or black ink, I use black powder paint. First, get a fine bristle brush and cut the bristles off about 3/4 of the way down, making the brush stiff and stubby. Then, get your black or dark brown powder paint (in powder form) and just paint it on as though it was normal paint. This makes a much more believable dirty look than brushing on regular paint and saves you the expense of buying an air brush. The powder paint can be smeared or dabbed on as you require. If you would like any more information, please write to me.

Andrew J. Cook  
121 Caversham Vly Rd.  
Dunedin, New Zealand

## Health Hazards

... I recently purchased the polyester resin mentioned in your "Making Monsters" article in CINEMAGIC #18. I thought I should warn other readers about the dangers of this product. I was working with the polyester resin to make a plastic helmet for a movie I'm planning. I ignored the safety precautions, and I paid the price for it.

The next morning, I was coughing and wheezing uncontrollably. I didn't feel well again for a whole week. When ever you're working with this product, keep adequate ventilation, and don't put your face too close to it (this is what I did).

Don't get me wrong, polyester resin is great, as long as you follow the directions to the letter. The same is true with all products you haven't used before. Don't be afraid to try new things, but be careful. As long as you take the necessary precautions, you may live to become a great filmmaker.

Chris Yeary  
Rt. 1 Box 112-1A  
Gunter, TX 75058

... CINEMAGIC #18 also contained David Hutchison's editorial warning about the health hazards of many substances used by special effects artists. This is a

very important subject and we're glad your letter gave us the opportunity to repeat the warning: Don't experiment with hazardous substances until you have taken all recommended precautions! The pamphlet "Health Hazards Manual for Artists" is available for \$3.50 plus 50¢ postage and handling from The Foundation for the Community of Artists, 280 Broadway, Suite 412, New York, NY 10007. The pamphlet recommends a number of safety procedures, devices and where to get them.

## New Zealand Film Club

... I live in New Zealand and have an interest in special effects filmmaking, special effects makeup and modelmaking. If any other readers in New Zealand share these same interests please write, as none of my friends share these interests and I always have to work alone.

Andrew J. Cook  
121 Caversham Valley Rd.  
Dunedin  
New Zealand

## Computer Animation

... I'm interested in finding and communicating with people using computers for filmmaking. I used an Apple II to create titles, credits and special effects animation for spacecraft instrument displays in the CINEMAGIC/SVA award winning film, *Asteroid* (see CINEMAGIC #16). If you have an interest in computer animation and special effects for filmmaking, please write to me at the address below.

James Leatham  
RD 2 Box 198 Laroe Rd.  
Chester, NY 10918

## Telecine Advice

... Before having your Super-8 film transferred to videotape, check the prices at as many companies that offer the service as possible. There is an unbelievable range in prices for telecine services. I found one company that charges \$8.95 per 400 ft. reel and I found another company that charges \$18.50 for the same 400 ft. reel. Of course, quality may vary from place to place, but it's still a good idea to

shop around.

Also, where can I get "countdown" leader? I had a rather nasty experience with one reel of film that I had transferred to videotape. The first scene was shot through a blue gel, and the telecine operator didn't get the picture focused until the normal scenes started! Give the telecine operator something to focus on.

Derek Mak  
104 Kingston crescent  
Kitchener, Ontario  
N2B 2T7, Canada

... Countdown leader is available from Super-8 Sound, 95 Harvey St., Cambridge, MA 02140. Their phone number is (617) 876-5876. Tell 'em CINEMAGIC sent you.

## Seattle Film Group

... I am a young filmmaker and I couldn't help noticing a plea for people in the Fort Worth, Texas area to join a film club. After reading that plea in Filmmakers' Forum, I decided to take the opportunity to make the same sort of plea.

Although I am not planning to form a club, I am looking for young (16-25) talented individuals who are interested in making films as a career. I need these people to specialize in various areas such as cinematography, music, art design, prop and model construction, costume design and any other jobs related to filmmaking.

If any CINEMAGIC readers who live in the Seattle/Tacoma area are interested, write me at the address below. My aim is to put together a quality film company and help each other achieve our eventual goals.

Mark Schellberg  
912 N. 96th #227  
Seattle, WA 98103

## G.I. Writer Seeks Producer

... I'm a G.I. stationed in West Germany. I have a tremendous love for special effects and the wizardry of film, but I don't have the facilities, the time or the space to make a live-action film for the CINEMAGIC/SVA Short Film Search.

I have written several high quality short live-action film

scripts that I feel would be winning entries in the Short Film Search if they were actually produced by competent cinematographers. As I am incapable of producing these films with my own limited resources, I would be willing to collaborate with another amateur filmmaker on one of these films, or send a story suggestion or general outline to an interested party. Anyone who is in need of plot ideas can contact me at my APO. CINEMAGIC, keep up the good work.

PFC Cleveland M. Blakemore  
505-02-0989  
A 1/83 FA, 8th Inf. Div.  
APO NY 09034

## Writer's Block

... I'm a new CINEMAGIC reader and I'm having trouble in producing a laser effect and also with scriptwriting. Can anyone give me some helpful information? Thanks.

Robert DeArce  
7005 Shore Rd.  
Brooklyn, NY 11209

... David Houston's three part article on scriptwriting appears in CINEMAGIC #'s 15, 16 and 17. It's one of the most useful and important articles that has ever appeared in CINEMAGIC. The many different techniques that amateur filmmakers have come up with for producing laser effects have been covered many times in the Filmmakers' Forum section. You can also try modifying Jeff Pollizzotto's technique for creating glowing "lightships" (CINEMAGIC #13) or Don Dohler's rotoscoping technique (CINEMAGIC #12) to suit your needs. Other techniques were revealed by readers in the Filmmakers' Forum section in issues #'s 12, 16 and 17 and in this issue. Any readers who want to help Robert should write to him.

## Make Your Own Music

... If you're looking for a way to add original music or sound effects (like buzzing bees) to your film or videotape, but can't afford to hire John Williams or a sound effects wizard, you might consider using the electronic Casio VL-1 Miniature Keyboard (sold at music, audio and large department stores). Although it costs about fifty dollars, you'll probably be able to create over fifty

different effects with it. This is because the keyboard features a mini-synthesizer, rhythm effects, and the sounds of six different musical instruments over a range of two-and-a-half octaves. An output jack makes it easy to hook the keyboard into other equipment, such as a VCR or amplifier. As well as being useful, the VL-1 is just plain fun and makes you feel as if you are an electronic John Williams!

**John Lewis**  
26137 Abdale St.  
Newhall, CA 91321

### Broad Appeal

... CINEMAGIC isn't just for filmmakers. Some of the articles are equally applicable to theatre and TV production, both of which I am a student of.

**Johnny Carruthers**  
Box 2481 Univ. Sta.  
Murray, KY 42071

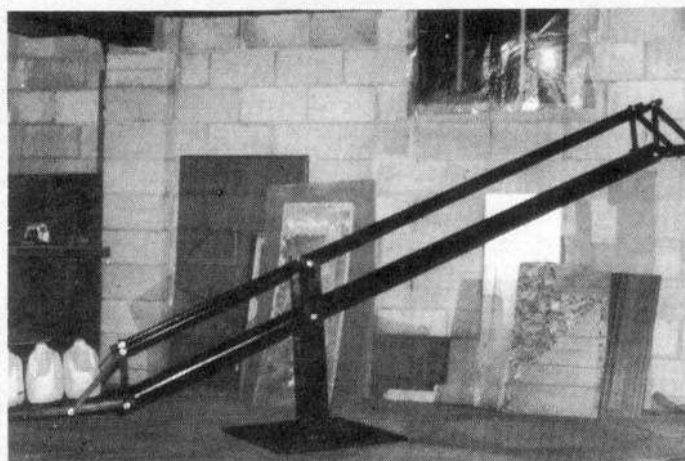

### Camera Crane

... The above photo is of a camera crane that I built from Ken Walker's design that appeared in CINEMAGIC #16. I

bought most of the materials from a local hardware store and the crane ended up costing less than \$60 to build.

Instead of using cinderblocks or bricks to balance the crane, I

use three one gallon plastic milk jugs. Two are filled to the top and the third is about 1/4 of the way full. Rope can be used to tie the bottles to the platform to keep them from falling off. Using water-filled containers for a counter weight is easier because they can always be emptied and easily carried back from a location along with the rest of the crane parts.

**Steve Bydal**  
2912 Jeffe Rd.  
Wilmington, DE 19808

Address all correspondence to:  
**CINEMAGIC—Filmmakers' Forum, c/o O'Quinn Studios, Inc., 475 Park Ave. So., New York, NY 10016**

Due to the enormous volume of mail received, the editor regrets individual replies are impossible.

## CINEMAGIC BACK ISSUES

**#1**—Backwinding Super-8 Film; Foreground Miniature Technique; Aerial Brace Construction.

**#2**—Spaceship Model-making; Blood Makeup; Smoke Generator; Light Beam Effects; Making an SF Logo.

**#3**—Robot Construction; Developing an Animation Style; Fluid Art Animation; Electronic Special Effects.

**#4**—Aerial Image Optical Printer Construction; Wire Armatures; A-B Rolling; More Electronic Special Effects; Fog and Mist Effects.

**#5**—Aerial Image Optical Printer Usage; Wide-screen Super-8; Slit Scan Effects; Gleaming Eyes for Stop Motion Models.

**#6**—Amazing Electronic Gadgets—Cheap; Bring Your Alien to Life—Latex Masks; Basic Editing Techniques; Invisible Man Effects.

**#7**—Basic Cartoon Animation; Claymation; Kaleidoscope Effects; Profile Santostephano.

**#8**—Video Tape Transfers; Reverse Filming Effects; Lab Services; Profile Vitous and Antonucci; Clash of the Titans Preview.

**#9**—Animating Pogo; Lithographic Titling Effects; Sets on a Shoestring; Profile The Langley Punks.

**#10**—Mastering Mattes; Zero Budget Sets; CINEMAGIC/SVA Awards Night; Building a Super Soundtrack; Pen Set Ball-and-Socket Armatures.

**#11**—Glass Shots; Miniature Explosions; Figure Animation; Bloody Hair Hunks; Profile Koch and Lohr.

**#12**—Makeup Magic—Latex Appliances; Rotoscoping; Zero Budget Ray Gun; Profile Barnes and Gilger.

**#13**—Slit Scan; Creating UFO "Lightships"; Model Interiors; More Electronic Special Effects; The Saturn Machine; Profile Borucki.

**#14**—Storyboarding; Sound Effects Generator; Miniature Devastated Cities; Charles Jones' 16mm Space Epic; Profile Jerry Parisi.

**#15**—Script Writing; Miniature Lighting; Electronic Special Effects; Careers: Super Depth in Dioramas; Profile Ralph Miller.



**#16**—Scriptwriting, Part 2; Electronic Special Effects; LED Circuits; Flat Art Explosions; Careers: Frank Van der Veer; Build Your Own Camera Crane; Profile Paady and Rudow.



**#17**—Scriptwriting, Part 3; Production managing Low Budget; Electronic Special Effects; CINEMAGIC/SVA Contest Rules; Secrets of Graphic Gore; Profile Callaghan and Griffith.



**#18**—Making Monsters; Tie-Downs for Animation Models; Accessories for Filmmakers; Electronic Special Effects; Profile: Al Magliochetti.



**#19**—CINEMAGIC/SVA Awards Night; Build your own Cobweb Spinner; High School Werewolf; Careers: Georges Melies; Electronic Special Effects; Front Light/Back Light Animation Technique.

**CINEMAGIC c/o O'Quinn Studios, Inc.**  
475 Park Ave. South, New York, NY 10016

Add postage and handling to your order: **\$ .80** for one issue; **\$1.14** for two; **\$1.60** for three; **\$2.00** for four; **\$2.40** for five; **\$2.70** for six; **seven eight.**

Check issues desired.  #10—\$3.00

#1—\$3.00  #11—\$3.00

#2—\$3.00  #12—\$3.00

#3—\$3.00  #13—\$3.00

#4—\$3.00  #14—\$3.00

#5—\$3.00  #15—\$3.00

#6—\$3.00  #16—\$3.00

#7—\$3.00  #17—\$3.00

#8—\$3.00  #18—\$3.00

#9—\$3.00  #19—\$3.00

NAME \_\_\_\_\_

ADDRESS \_\_\_\_\_

CITY \_\_\_\_\_

STATE \_\_\_\_\_

ZIP \_\_\_\_\_



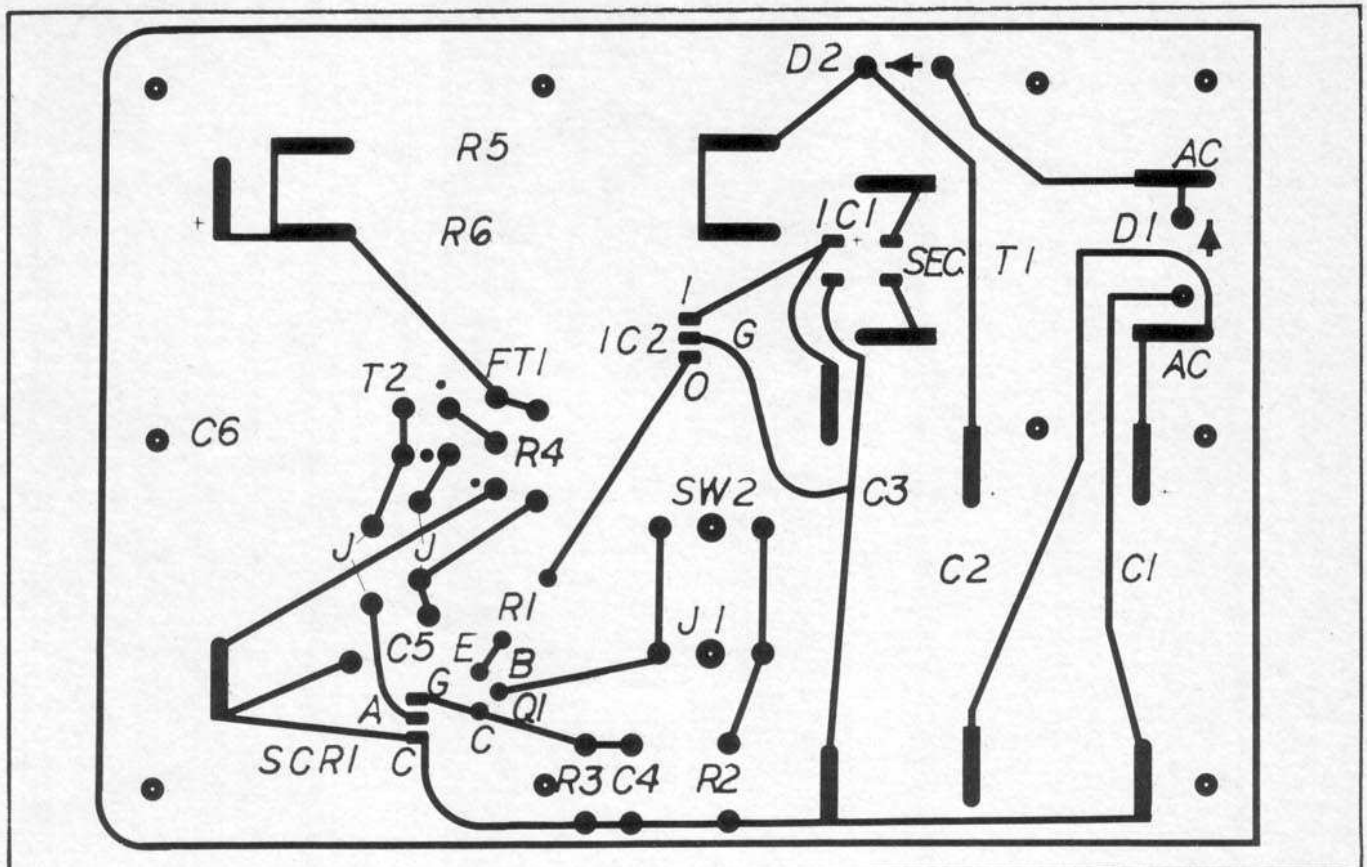

This is the PC pattern and parts placement diagram, shown actual size. Use this pattern to make your PC board. Refer to CINEMAGIC #13, page 29 if you're not familiar with the procedure for etching a PC board. Drill only the dots with the white dots in the center. Make absolutely sure that all parts are properly in place before plugging this unit in. Make especially sure that C-1, C-2 and C-6 are correctly installed because these parts could explode if improperly installed.

the next few weeks, so that I can place an early order, and then get them to you as soon as possible. Once the order is placed, it'll take a few weeks for the parts to arrive, and then get them shipped to you. Figure on 8 to 10 weeks for delivery.

I know that those of you who are building this project have a lot of money wrapped up, and I want to do as much as I can to help you complete it with success. These articles are written months in advance, and neither I, nor Radio Shack had any idea then that this would come about.

The project for this issue is simple, compared to the sound effects project. It's a strobe that can be used for photographic purposes, much like the strobes used in still photography. The difference being, that this has a fast recharge rate, allowing for multiple flashes in rapid succession, as compared to the average ten seconds of recharge time for the still photography strobe, and it can be used with movie cameras with a sync output. If you recall, there was an article synchronizing a flashbulb with a movie camera in CINEMAGIC #6, a creation of Ken Walker. We've taken that same idea, but have gone a little farther, hopefully creating a versatile tool for some creative movie photography.

If you have a movie camera with a "sync" output, in reality what you have inside the camera is a switching arrange-

ment that makes contact every time the shutter opens. This is a very light duty switch, and cannot handle high voltages or heavy load currents without burning out. Taking this into consideration, I've designed a high-voltage strobe, similar to the strobes found in a disco, and then added a low voltage, low current switching arrangement so that it would protect the delicate sync switch in the camera. Even though the circuitry has been eliminated that caused the unit to flash by itself, it's still basically the same type, with a few modifications.

Here's how it works: AC enters through SW-1 and F-1 and is rectified to DC by D-1, 2 and C-1, 2. This causes the voltage to double and is fed to C-6 and the flash tube through limiting resistors R-5, 6. The AC also supplies power to the transformer which provides the low voltage for the triggering of the SCR. SW-2 is a pushbutton switch for "test" and manual flash. Also connector J-1 is in parallel with the switch, and is connected to the camera, or another pushbutton switch for manual flashing via an extension cable.

There are a couple of things that you should take into consideration. The first consideration is that this is a high voltage unit. You're dealing with quite a shock potential and you *must be sure* that you have everything wired correctly, and that there are no short-circuits in your wiring. I

accidentally got my hand across the high-voltage end of this thing, and very promptly got set back on my can. My hand was numb for a couple of days. Another thing, is that if you are prone to have epilepsy, there is a chance that the rapid flashing of the light may set off a seizure. If that is the case, I suggest that you consider waiting and building another project. And, if you're still relatively new at building projects, or have *any doubt* about your work, I'd suggest that you seek out someone with the qualification necessary to properly check out your work. Be especially sure that C-1, 2 and 6 are correctly installed. If not, the potential for one of these capacitors literally blowing up is very high, and can sink little bits of schrapnel into the wall (or your face). When everything is done correctly, you'll have a safe unit, but if not, I can't over emphasize the danger potential.

Use the photograph of the project as a guide. This will help you identify several different aspects of the project, and help you achieve success the first time. On the low voltage side, the most amount of current that the camera contacts will be switching, will be 5 volts, at about .055 amps (two milliamps) which is very low, and shouldn't cause any damage to the camera.

When installing the transformer T-1, put the mounting bolts through the PC

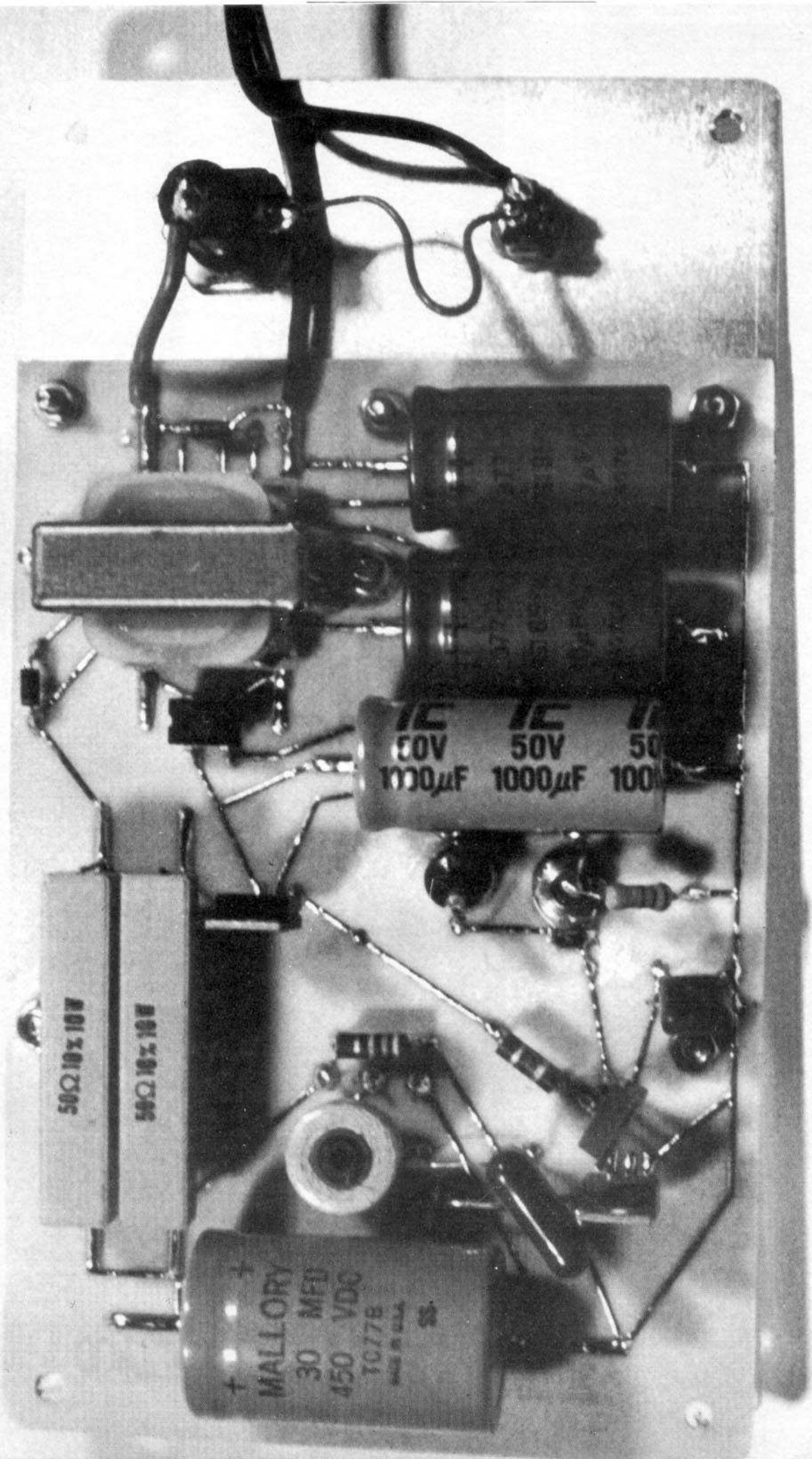

50Ω 10 x 10W

50Ω 10 x 10W

MALLORY  
30 MFD  
450 VDC  
TC77E  
MADE IN U.S.A.  
25

1000µF 50V  
1000µF 50V  
1000µF 50V



board and then run a nut down on each bolt *before* you mount the transformer. Then add the nuts that hold the transformer. The reason for this, is that the extra nuts will provide space between the transformer and the circuitry beneath the transformer body, keeping it off the circuitry, and preventing a short circuit. That's high voltage, high current stuff there, and you've got to be sure that there is no contact between the transformer and the circuit. On IC-2, there are "I", "O" and "G" labels. These are for in, out and ground connections on that particular IC. On the layout, there are two "J's" which are for jumper wires. Also at T-2, there is an extra little dot, which will correspond to the red dot on the trigger transformer, and the other dot, is for the negative, or heavy

electrode side of the flash tube, FT-1. Make sure that you get the tube polarity correct, as it will make sure that you get the maximum life out of the tube. If you wish, you can use the jumbo flashtube instead, and you don't have to make any changes in the circuitry.

When drilling the PC board, drill the holes for mounting, the transformer and for the safety shield (should the tube shatter and explode) as well as the holes for the rest of the original project box cover. Before you mount any of the parts, make your measurements for the remaining part of the cover, and drill the holes at the same time for a perfect match. Also, when you get your PC board, and before you try cutting it to size, use the box cover as your pattern. This will give you an excellent and

exact fit to the project box. Since the PC board is 6"X6" it'll be too short to fit the length of the box, and the time to cut the cover and fit it, is after you get all of the holes drilled.

For the safety shield, I went to my local hardware store, and got some acrylic plastic scraps that are cut-offs from their glass cutting department. Since many hardware stores supply acrylic plastic for the replacement of window panes, you shouldn't have any trouble finding any. And as a final touch, I went to my local hobby shop, Bill's Hobbyland, (very friendly people) and acquired some Top Flight brand Monokote™ trim sheets, which is used for covering model remote controlled aircraft. This is a self-adhesive plastic cover and comes in several col-

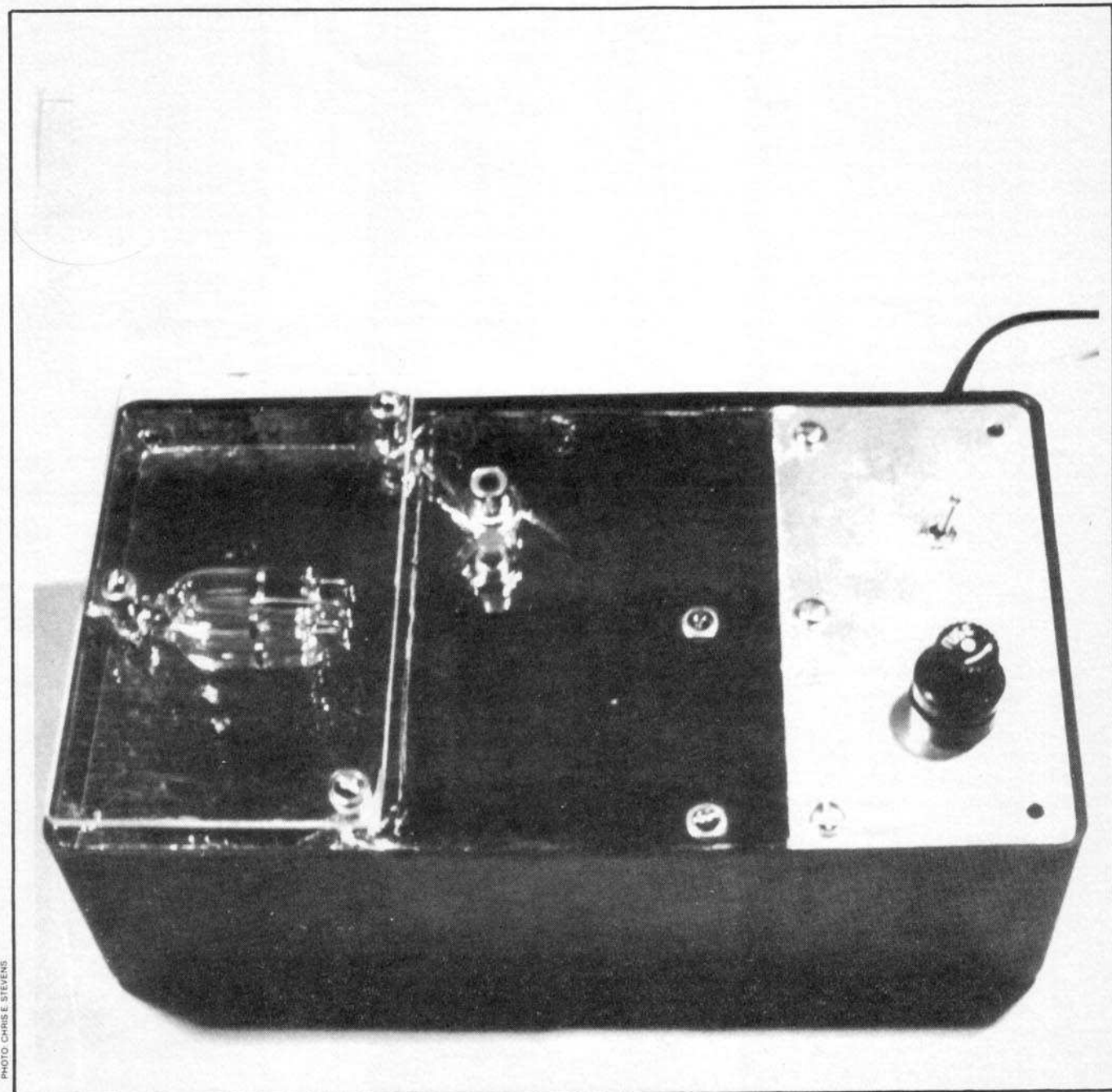

PHOTO CHRIS E. STEVENS

**Opposite page:** A top view of the completed movie sync strobe circuit with all of the parts in place. You can use this photo as a parts placement reference. Make sure all parts are properly installed before plugging the unit in. **Above:** A view of the completed project. Note the acrylic plastic safety shield covering the strobe tube.

ors, as well as high-reflective metal color. It is slightly conductive, so make sure that you punch adequately sized holes where the tube leads pass through. Otherwise, you'll get arcs when the tube flashes. (Which reminds me; besides the mounting, transformer and shield holes, the only others drilled are for the flashtube and for SW-2 and J-1, plus the switch and fuseholder in the box cover.)

When mounting IC-2, Q-1 and the SCR, take a pair of pliers and bend about 1/8" of the leads at a 90° angle, so that you have a base for mounting the parts. Tin the whole board lightly, and then add solder as you need it. First attach one lead to hold the part in place, and then solder the remaining leads. On IC-1, the same procedure is used. I've noticed that more and more manufacturers of electronic equipment are mounting the parts in the manner shown here, and since it saves a lot of time and drilling, I can't see any reason why we can't follow suit. It seems like a very efficient and time-saving way of doing things.

I want to re-emphasize that this can be a touchy and dangerous project for the inexperienced builder. Neither I or CINEMAGIC will accept, assume and/or imply *any* responsibility for any accidental injury or death resulting from this project, directly or indirectly caused. You are building this project totally at your own risk. Again, if in *any doubt* have it checked out by a qualified technician before you plug the unit in. As a normal procedure, I try to build safe, low powered projects for your enjoyment, but this project is an exception. Anytime that AC voltage and current is employed, it should be a rule that you exercise extra care and caution.

On a final note, Radio Shack does not stock the capacitors, C-1, 2, 4 and 6. You may acquire them through almost any local tv repair shop, or parts distributor. If you wish, you may also order them from me, through CINEMAGIC. The cost for the four capacitors is \$16.25, plus \$2.00 P&H, for a total of \$18.25. Allow 4 weeks for delivery time. Also, the total cost of the project is estimated at \$45-\$55 per unit, depending on whether or not you have any useful parts left over from other projects, the price could be lower. Prices will vary and the remainder of the parts besides the capacitors are available at your local Radio Shack stores.

### Let's Hear From You!

I'd really like to hear your suggestions for electronic special effects projects. If I can, I'll answer your questions about how some of the effects are done. Also, I'd like to know how your projects turn out, and how you use them. For the next project, you might see a light "chaser" system, similar to the one used in the *Buck Rogers* TV series, which is used to create the "light cables" running to the individual craft in the launch bay. The lights seem to flow toward the craft in ripples.

CM

# PARTS LIST

## Movie Sync Strobe Unit

	AC line cord	278-1255
SW-1	SPST switch	275-624
SW-2	SPST pushbutton switch, N.O.	275-1547
F-1	1 A. 3AG fuse	270-1273
	Fuseholder	270-364
D-1, 2	Diodes, 1A 600PIV.	276-1104
C-1, 2	10 uF 450VDC Electrolytic	*
C-3	1000 uF 35VDC Electrolytic	272-1019
C-4	.1 uF Disc ceramic capacitor	272-135
C-5	.1 uF Disc ceramic 400VDC	*
C-6	30 uF 450VDC Electrolytic	*
IC-1	Bridge rectifier	276-1161
IC-2	5 volt regulator	276-1770
Q-1	PNP Transistor	244-2027
R-1	68 ohm 1/2 watt resistor	271-010
R-2	2.2 K-ohm 1/2 watt resistor	271-027
R-3	1 K-ohm 1/2 watt resistor	271-023
R-4	470 K-ohm 1/2 watt resistor	271-053
R-5, 6	50 ohm 10 watt resistor	271-133
SCR-1	6 Amp 400V Silicon controlled rectifier	276-1020
FT-1	Strobe tube	272-1145 or 272-1147
T-1	Transformer 6.3 V. Sec; 300 Ma.	273-1384
T-2	Trigger transformer	272-1146
	PC board 6" x 6"	276-1587
	Project box	270-232
J-1	RCA type phono jack	274-346

Misc: Acrylic plastic safety shield, Monokote™ covering, 4-40 hardware, line cord grommet.

**PARTS LIST:** As a convenience, the catalog numbers listed are Radio Shack numbers, except those marked with an asterisk \*. For those parts, see the text.



"W-What do you mean something ate the cat?"

# BULLETIN BOARD

Please forward announcements of film projects in current production or near completion to CINEMAGIC, c/o O'Quinn Studios, Inc., 475 Park Avenue South, New York, NY 10016. Please include a photograph of some phase of the production if possible.

**You Dirty Rat!** Parody of 30's gangster movies, The rags-to-riches story of the rise and fall of Frankie "The Feet" Feeney, who almost made it to the top of the world, but had to finally choose between success in the underworld and loyalty to his life-long pal, priest Pat Pending. Producer/Director/Writer/FX: Tom Triman. Voices: June Winslow, Tom Triman. Music: Craig Inglis, Ron Mandlecorn. Song, "Patiently Waiting" composed by June Winslow and performed by June Winslow and Jim Valley. Production Assistant: Beth Triman. FX include: puppet animation, lap dissolves, wipes, multiple exposure montages, foreground transparencies and miniature sets, Super-8, color, sound. Running time: 52 minutes. Copyright © 1982, Tom Triman and on file in the Library of Congress. (Tom Triman, 311 Guinida Lane #4, Anaheim, CA 92805.)

**Warriors of the Scarlet Dimension.**

A science fiction/fantasy tale of the frantic struggle for a mysterious cube which can control nature, thought processes and eventually mass armies. The struggle is between three vicious alien mercenaries, pursuing one another through different dimensions, eventually materializing on Earth and making it their final battle ground. Their greed knows no limits, as they take control over two friends who have secretly acquired the cube, never realizing for a moment the devastating power the cube contains. Producer: Gus McPherson. Director: Bob Badway. FX include: psychedelic dimension shots, original alien mask designs, miniature sets, rear projection and in-camera mattes. Super-8, color, possible sound. (Centicon Productions, 20 Dyer Ave., Riverside, RI 02915.)



**Stone Walls Do Not A Prison Make.** Based on *The Prisoner* television series starring Patrick McGoochan. A secret agent quits his job and is abducted by people who bring him to The Village. Here he is allowed to do almost anything—except leave! Producer/Director/Writer: Jonathan Pasternack. Props: Jay Reiss, costumes: Barney's, New York. Editor/FX: Mike Pasternack. Cast: Michael Pasternack, Morton Steuer, Mark Bellman and Jack Roberts as number 2. FX include: spectacular stunts, secret service underground compound set. Filmed on location at the Hotel Portmerion, Wales; London, England; and Amsterdam, Netherlands. Super-8, color, musical soundtrack on cassette. Running time: approximately 15 minutes. In post-production. (Pasternack Productions International, c/o Johnathan Pasternack, 720 East 19th St., Brooklyn, NY 11230.)

**The Summons.** After being assaulted, a young boy summons the demon Nqal-Narach to destroy his attackers, with surprising results. Producer: Dungeon Productions. Director/FX: Steve Kundrat. Cast: Mark Cunningham, Jeff Cunningham, Lenny Wells and Jim Hamilton. FX include: stop-motion animation, blood makeup effects, bleached emulsion. Super-8, color, silent. Running time: 3-4 minutes. (Steve Kundrat, Dungeon Productions, 6204 Pleasant St., Liberty, PA 15129.)



**The War Story.** The tale of an American G.I. being held prisoner of war by the Japanese on an island in the South Pacific during World War II. Will his attempt to escape succeed? In pre-production. Producer: Lackson Productions. Director/Cameraman: Cary Simpson. Writers/FX: Cary Simpson and Mark Lackey. Cast: Mark Lackey, Mark Epps, Brian Simpson, Brian Schock, Brian Armstrong and John Little. FX include: blood makeup effects, graphic gore and graphic battle scenes. Super-8, color, cassette soundtrack. Running time: 10-12 minutes. (Lackson Productions, c/o Cary Simpson, 70 Raccoon Lane, Deerfield, Myrtle Beach, SC 29577.)

**The Tomb of Mondragor.** Imagine that you are spending the night in a prehistoric burial chamber. Imagine that you don't realize it until too late. Now imagine that there's something in there with you. Producer: Crescent Pictures. Director/Writer: Ken Newberry. Co-Producer: Linda Newberry. Cast: Keith Ransom, Susan Keon, Bob Newberry, Christine Martin, Elaine Parris, Linda Newberry and Barry Collins. FX include: mattes and special makeup effects. Super-8, color, sound. Running time: approximately 30 minutes. (Crescent Pictures, c/o Ken Newberry, 47 Sheals Crescent, Maidstone, Kent ME15 6TW, England.)

**The Cult of Jardin.** A writer for a fashion magazine burns down a castle belonging to a Caribbean voodoo cult. Witches, cultists and zombies start to kill the writer's friends and family. Producer/Director: Derwin Mak. Cinematographers: Rob Glover and Kevin Schlueter. Screenplay: Derwin Mak and Stephen Logan. FX: Stephen Logan. Cast: Stephen Logan, Anne Snyder, Margaret Leeder and Brad Sharpe. FX include: bloody human sacrifices, a giant preying mantis, burning castle and lots of zombies! Video with Super-8 telecine scenes. Running time: not established. In post production. (Derwin Mak, 104 Kingston Crescent, Kitchener, Ontario, Canada N2B 2T7.)



**Creaturealm.** A trilogy in which an animated version of death talks between the three stories. The first tale, *Werewolf*, is about a babysitter who gets more than she bargained for when the kid she's babysitting for turns into a werewolf and stalks her about the house. Werewolf lasts for about 20 minutes. The second story, *War*, concerns two aliens battling in their spaceships to the death. The winner's victory is cut short when he is crushed by a monstrous human hand. He was nothing but a bug, squashed by an annoyed insomniac. *War* lasts 10 minutes. The last story, *To Wake the Dead* is about three boys snowed in in one of their houses. Discovering a hidden room in the basement by accident, one of the boys brings a book back up, reads several spells from it, and unwittingly awakens the vengeful and very hungry dead. It so happens that the house is located next to a huge graveyard. Shot mostly on location, this story lasts about 13 minutes. Producer: Brimstone Productions. Director/Writer/Cameraman: Kevin J. Lindenmuth. Cast: Wendi, April and Audra Lindenmuth and Saed Shoucair. FX include: cartoon animation, clay animation, original spacecraft models, matte paintings, scratch-on laser effects, special effects werewolf makeup, a life-size, moveable werewolf head for close-ups and two zombies. Kevin Lindenmuth, 36038 Crompton Circle, Farmington Hills, MI 48018.)

**Company for the Night.** A quiet tale of a corpse who after a hundred years, yearns for the warmth and companionship of the living. He leaves the grave and joins an elderly couple for the night. Producer: ONO Productions, Ltd. Director/Writer/Camera: John Dixon. FX include: stop-motion, animation, miniature cemetery set and house set. Regular-8. Running time: 20-30 minutes. (ONO Productions, Ltd., c/o John Dixon, 323 S.W. 14th St., Pendleton, OR 97801.)

**Life is Just a Fantasy.** Fantasy/comedy. Joe is an average young man with a love for science fiction and fantasy films. But Joe's life becomes entangled in his dreams, and he wonders, at what point does fantasy end and reality begin? He finds his answer as he becomes the most *human* superhero ever. . . . Producer/Director: Ron Lawrence. Cast: Joe Rapien, Susan Sloan, Doug Murdock, Duane Moch, Shirley MacQueen, Wallace Trevains. Super-8, color, musical soundtrack on cassette. Running time: approximately 4 minutes. (Ron Lawrence, 1615 Beacon St., Cincinnati, OH 45230.)

**David Jensen: Applicant for Insanity.** David Jensen, a rehabilitated video addict who has dedicated his life to the elimination of video addiction, is at the shooting premier of his national television show when his insanity reclaims him and he is forever banished to live in the surrealistic world of his own mind. Producer/Director/Writer: Mark Robert Halper. Cast: Dave Cohen and Staysi Samuels. Super-8, color, sound. Running time: 14 minutes. (Destination Films, c/o Mark Robert Halper, 13140 Bassett St., North Hollywood, CA 91605.)

**Starship Trooper.** No relationship to the Robert Heinlein book of the same title. The story of the accidental signing up of a young man into the Space Patrol. The film follows his adventures from becoming a starship trooper to a victim of war. A comedy with many sight gags. Producer: Millenium Movies. Director: Peter N.R. Briggs. Assistant Director: Gregory Welsh. In pre-production. FX include: animated medical scanners, laser effects, stop-motion animation, miniature spacecraft, fog effects, pyrotechnics, rear and front projection, computer animation and extensive matte work. The film is mostly live action. Super-8, color, elaborately mixed soundtrack to be added. (Peter N.R. Briggs, 33 Cherry Tree Close, Prescott, Merseyside L35-2XJ, Great Britain.)

**Flight to Eternity.** In the year 1993 the U.S. Space Shuttle "Challenger", piloted by Colonel Taylor and Major Mathews, embarks on a routine mission only to be blown out of orbit by shockwaves from a nuclear war. After encountering a Russian killer satellite in deep space, they must find a way to get back to Earth. Producer: Atlantic Pictures. Director: Ronald Lennstrom. Cast: Al Salopek, Kevin Glover. Cinematography: Bruce Hiensius. Miniatures: Tim Conrad. Sound: Dov Schwartz. Optical Effects: Larry Bowman. Lighting: Irv Wiess. FX include: a full size shuttle cockpit, astronaut flight suits, lap dissolves, multiple exposures, miniatures, optical effects and more. Super-8, color, double system sound. Running time: approximately 40 minutes. (Ronald Lennstrom, 536 N. Larchmont Blvd., Hollywood, CA 90004.)

**Lycanthropy.** A teenager stumbles across a radioactive moonrock which has plummeted from space, landing in his backyard. He is irradiated, causing him to black out. After finding the corpse of his brother in the house and seeing a newspaper telling of the moonrock, he realizes the shocking truth: He is a werewolf! Surprise ending, Producer/Director/Writer: Craig Robinson. Cast of ten, featuring Brett Robinson, Jason Piekarz and Glen Toof. FX include: blood makeup, meteorite effects, werewolf makeup and miscellaneous title and lighting effects. Super-8, color, soundtrack on cassette. Running time: 15-20 minutes. (Craig Robinson, 2407 Brentwood Rd., Sacramento, CA 95825.)

**The Big Hurt.** The final film in a series of original episodes concerning two mis-matched detectives and their search for an international fugitive. This assignment takes them on a free for all chase through the countryside of the United States, France, England and the ozones. Producer: Kiser-Welch Productions. Director: Gary Kiser. Writer: Stefan Welch. Cast: Kristine Kiel, Mark Williams, Peter Stearns, Kristy Miller, Gary Kiser and Stefan Welch. FX include: character generated titles, matte shots, glass paintings, pyrotechnics and spacecraft miniatures enhanced with fiber optics and stop-motion animation. Super-8, color, sound, musical soundtrack in stereo. Running time: 70 minutes. (Kiser-Welch Film Productions, P.O. Box 441, Cuyahoga Falls, OH 44222.)

**Touch of Death.** The year is 1966. A man is murdered in a forest and buried under the forest floor. Seventeen years later, a bolt of lightning brings him back to life, bent on revenge. A series of horrible murders follows. Producer: BCS Films. Director: Joe Craparo. Writer/Cinematographer: Mike Baedicker. Music/Sound: Ray Shupa. FX include: rotoscoping, makeup effects and special stunt sequences. Super-8, color, dubbed sound. Running time: 13 minutes. (Mike Baedicker, 7 Markay Ct., Binghamton, NY 13905.)

**Eugene Gets Rad.** Comedy. The adventures of a common whip who strives to be a B.M.X. champion. Producer/Director/Script: Roger Camacho. Cameramen: Robert Bell and David Marder. Cast: Roger Camacho, David Marder, Elliot Nathenson and Eric G. Editor: Robert Bell. Super-8, color, silent with captions. Running time: 8-10 minutes. (Robert M. Bell, 10660 S.W. 93rd St., Miami, FL 33176.)

**Operation Space Shuttle.** A space shuttle mission is destroyed by a laser-armed satellite that gets its power from an abandoned laser station in a mountainous region. A starfighter pilot must destroy the laser-armed satellite within 72 hours or another shuttle will be destroyed. Does he have enough time? Producer: Bandit Productions. Director/FX: Jeff Bristow. FX include: pyrotechnics, laser effects, miniatures and starfields. Super-8, color. Running time: not established (Jeff Bristow, 1425 N. Arapahoe, Amarillo, TX 79107.)

**The Exiles.** Two hell-raising Martians are kicked off their own planet and try to make a new home on Earth. Producer/Director/FX: Kevin Soule. Cast: Kevin Soule, Wally Siems, Steve Vollmer, Jim Nelson & Wayne Unruh. FX include: stop-motion animation, fixed and traveling mattes using a variation of John Cosentino's aerial image optical printer (See CINEMAGIC #'s 4 and 5). Super-8, color, sound. Running time: 15 minutes. To be submitted to the 1983 CINEMAGIC/SVA Short Film Search. (Kevin Soule, 818½ N. 18th St., Bismark, ND 58501.)

**Planet of Doom.** Three astronauts transporting nuclear missiles through space are forced to land on an uncharted planet. They take refuge in an ancient structure resembling a church. The terror begins when the captain is abducted by a race of mutated beings who inhabit the planet. Producer: G.P. Films, Director/Writer: Gregg S. Paine. Cast: John B. Kilbridge, Mike Lacky and Paul Tarantino. Super-8, color, sound. Running time: 15 minutes, (G.P. Productions, c/o Gregg Paine, 15 Conestoga Ct., Franklin Lakes, NJ 07417.)



**Commercial Commercial.** Comedy. A fast paced story of two commercials which don't exactly look normal. Producer: Four Associates Productions. Director/Writer/FX: Johnny Banta. Storyboard design: Johnny Banta, Tim Harris, Kevin Mentor, Craig Broderdorp, and Nels Wroe. Cast: Marilee Toolson, Johnny Banta and a cast of creatures. FX include: stop-motion animation, werewolf transformation makeup, computer animated titles and matte paintings. Super-8, color. (Johnny Banta, 1131 Washington St., Douglas, WY 82633.)

**Checkmate.** A young man is obsessed with chess and fancies himself an expert. Things go well just as long as he wins, but when he loses....Producer/Director/Writer/Editor/Camera: Thomas Sipos. Cast: Frank Craven, Ange Berneau, Iris Dorbian, Everett Sherman, John Morgan, Susan Sipos, George Morgan and Russel Stidolf. Super-8, color, sound. Running time: 25-30 minutes. Script registered with WGA-East and copywritten with the Library of Congress. (Thomas M. Sipos, 31 Fleet Street, Forest Hills, NY 11375.)

**The Curse of the Amulet.** A young man finds an Egyptian amulet in a chest in a trash can on a suburban street. It saves him from death, but without realizing the amulet's power, he gives it away to a friend. Now starts the ancient curse of the amulet! Producer/Director/Writer/Makeup: Michal Pasternack. Cast: Mark Anieves, Mark Centerman, Albert Ramirez. FX include: stunts, old age makeup, blood and trained animals. Super-8, color. Running time: 10 minutes. (Pasternack Productions International, c/o Michael Pasternack, 720 East 19th St., Brooklyn, NY 11230.)

**Corvus Meets Dr. Draco.** An adventurous hero-type and his scientist side-kick are called on to execute an important mission: to stop the sabotage on the main power-producing planet in the galaxy. Producer/ Director/FX: Jerry Lemaitre. Script: Ramunas Lapp and Jerry Lemaitre. Cast: Wayne Holotuk, Jerry Lemaitre, Ramunas Lapp and Omnicron 5000 (a robot.) FX include: spaceship miniatures, monster and robot makeup, miniature city scape, laser FX, explosions and a spaceship interior set. Super-8, color, sound. Running time: 10-15 minutes. (Jerry Lemaitre, 14 Clarkson Rd., Collingwood, Ontario, Canada L9Y 3B7.)

**Cold Logic.** An overworked astronaut, a woman in the wrong place at the wrong time, and a computer looking after the corporation's best interests, far from home... "Jeezus! I've never had to kill anyone before." Producer/Director: Kevin Bjorke. Cast: Nicholas Ballas, Megan Butler, Gerald Ollison, David Clarke and a computer voice module. Cinematography: Ralph Oshiro. Musical score: Lynn Hamill. Storyboards/Prod. Design: David Thomas. Matte paintings/Prod. Design: Andrew Kenworthy. FX: Kevin Bjorke, Kelly Fije, JT Moore, Janet Schickling and Joe Celeste. FX include: miniatures, high-speed photography (300 fps), computer graphics, computer controlled animation, articulated mattes, pyrotechnics, robots, mechanical sets, videotape/computer feeds, electronicized props, wind, pressurized smoke jets. 16mm, color, sound. Running time: 10-15 minutes. P.S. We can always use more local help. (Kevin Bjorke, 24700 McBean Parkway KA-14, Valencia, CA 91355.)

CM

# The Jointworks

Animator Bill Hedge has launched a company called *The Jointworks* to make precision modular ball-and-socket armatures available to amateur animators.

By NICHOLAS SELDON

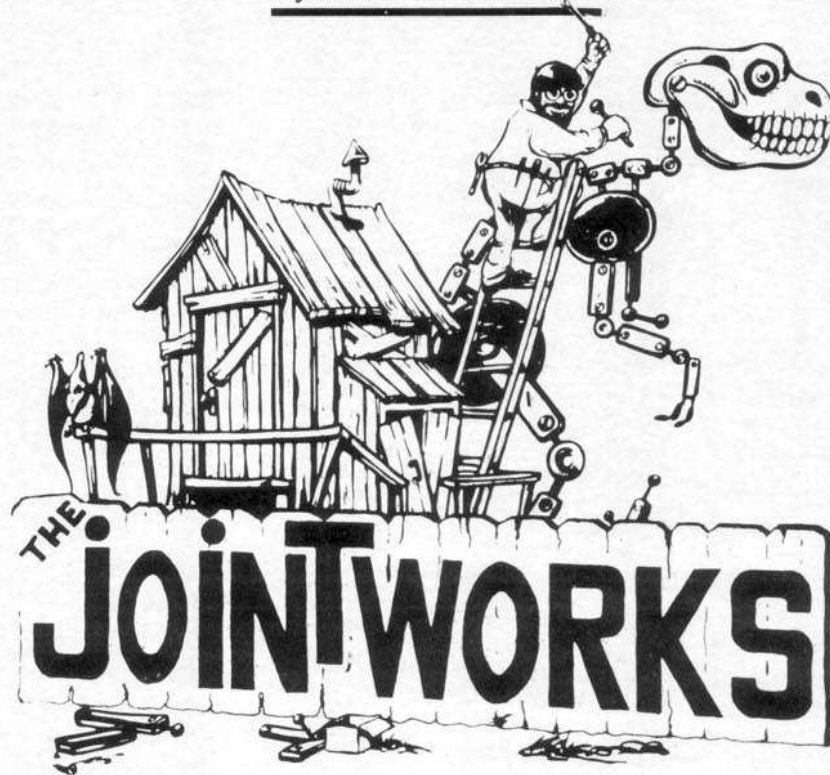

**T**here are simply no two ways about it: animation with a wire armature just can't compare to animating with a machined ball-and-socket armature. Ask Bill Hedge. He's done both and gave up wire as soon as he learned how to operate a lathe. "It comes down to control," says Hedge, a force in the Hollywood stop-motion scene for fifteen years. "Stop-motion by its very nature contains a lot of guesswork, but a good ball-and-socket armature can put the animator in a whole different frame of mind. Instead of grabbing hold of a foam-rubber arm or leg and praying it will go where you want it, an animator using ball joints can be certain the puppet will go where he wants it to, and stay there."

Hedge, who reminds one of a sort of laid-back Sebastian Cabot, relaxes in his seat and runs his hand over the flecks of premature gray in his beard. "And wire breaks," he adds with a pained smile, "at all the wrong times." He laughs roundly.

The reason he's laughing is because he's just launched a venture that will once and for all put an end to puppets that have a hard time just standing up, and once they do, move like they're fighting ninety-mile-an-hour winds. It's an idea that's been tossed around town for years and now it's here. It's called *The Jointworks*, and its

## The Joint Works . . . Somebody FINALLY Did It!

chief product is a modular ball-and-socket parts system precision-made on a computerized mill. The company offers four sizes of professional quality components that can go together with astonishing speed to create anything from a dragon to a perfectly-scaled human being.

Hedge is no newcomer to the travails of stop-motion. A charter member of the Southern California animation clique since the Sixties, he's worked with Jim Danforth and Dave Allen, building armatures professionally as far back as *When Dinosaurs Ruled the Earth*. More recently, his work has appeared in Mel Brooks' *History of the World, Part One*, *Airplane*, *Piranha*, and several Chuckwagon and Pillsbury T.V. spots. One of his latest creations is a living face carved in the side of a cliff, produced for the television series *Wizards and Warriors*.

The *Jointworks* is Hedge's first venture to make a direct link with stop-motion enthusiasts so that budding animators can profit in a practical, first-hand way from his experience. "It's the technical problems that so often extinguish the beginner's enthusiasm," Hedge explains. "The

*Jointworks* is designed to lift amateurs over the initial tooling-up headaches, so they can direct their attention where it rightly belongs, in the conceptual and artistic end of things." It's a service he admits to wishing he had available to him when he was a beginner. "It's well within my ability to imagine myself simply giving up on stop-motion when I was younger, because of the frustration. Getting these puppets to move is hard enough, but wrestling with wire, particularly in the legs, is nothing but a hassle. You have to shoot on twos because your moves are bound to be gross, and every move has to be overstretched to accommodate the memory that wire has by nature." Fortunately, when Hedge was a neophyte animator he already had a background in machining that enabled him to meet the challenge. He continues, "Oh, I knew that Jim (Danforth) and Ray (Harryhausen) had sophisticated ball-and-socket jobs, and all anybody had to do was look at the footage they were getting to see the difference that made. Far beyond just having their animals move, their puppets were acting! It was like comparing John Agar to Laurence Olivier. That was the competitive edge I knew only an advanced armature could give, and that in turn gave me the incentive to experiment

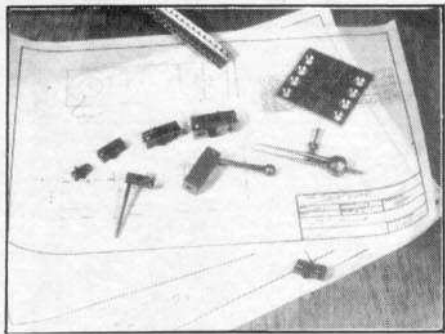

The Jointworks represents the first time that a standardized, modular ball-and-socket system used by professionals has been made available to the general public. The parts can be assembled with very few tools.

and never give up, which led to my founding The Jointworks to help other animators get started.

The company works like this: Each parts catalogue contains not only a list of inventory but also a Design Guide packed with step-by-step instructions on how to assemble arms, legs, hips etc. How to modify the joints to create custom armatures. How to fabricate skulls, hinged jaws, and feet. How to mix and apply special flexible paints. How to mix foam rubber, then inject it and cure it in molds you make yourself. Everything the novice needs to know to make the big step to professional calibre puppets.

In addition to the actual ball-joint components, which can be altered to form virtually any configuration imaginable, the company also stocks artificial eyes—animal and human—as well as two grades of form rubber, tie-downs, camera filters, fake blood, smoke charges and more.

"I want to be a full-service supplier to hobbyists and really low-budget filmmakers," says Hedge. "Anything having to do with stop-motion and makeup effects, we have. And if we don't just tell us what you want, and for a search fee, we'll find it."

And, for those whose vision exceeds their capabilities, The Jointworks will bid on custom fabrications, given specific drawings. "I've got the contacts," Hedge goes on. "You say you need a skull for an arsontherium? I can have one cast and machined in aluminum to exacting specifications."

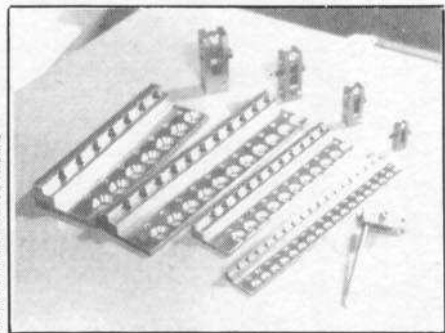

PHOTO: COURTESY THE JOINTWORKS

The four different scales that The Jointworks offers allows for a wide range of sizes of stop-motion armatures. The parts can be assembled to create anything from a dragon to a perfectly scaled human being. The stainless steel components won't corrode foam rubber.

Speaking of exacting specs, Hedge points proudly to the tolerances on his joint components. "These parts are cut on a computerized mill," he beams, holding four glistening pieces of steel that make up a handful. "And our ball bearings are stainless steel, lapped to within one ten-thousandth of an inch of spherical." Lapping is a surfacing process in which the ball is literally ground against a flat surface, like being sanded, instead of the cheaper technique of tumble-grinding. It gives the ball a more consistent surface texture for more even moment. And because they're made out of stainless steel, no annealing is needed, they're easy to silver solder, and they won't be corroded by foam rubber. Not only does corrosion make joints harder to move, but it discolors the rubber and gives your puppet a big black stain right at the joint.

By the way, for anyone who's ever tried to drill a ball bearing, The Jointworks' bearings are pre-drilled half way through. On dead-center. "Think of the savings on aspirin alone!" Hedge laughs.

"Look, I'm coming at this from the

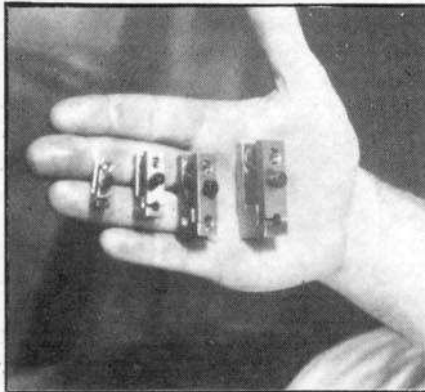

The four different sizes of ball-and-socket components available from The Jointworks are shown in Bill Hedge's palm to give you an idea of their relative sizes.

standpoint of a fan," Hedge continues, "from what I would have liked to see in the back of Forry Ackerman's magazine, instead of masks and ten-dollar movie projectors. I was willing to experiment back then. But parts like the ones I'm offering would at least have given me a fighting chance, and I think a lot of people who don't have access to machinery and professional help feel the same way. That's why I've got the Design Guide. What's the use of selling them a set of parts unless they know what to do with them? The Guide is like having me right there, guiding them through every step of assembly." Hedge goes on to explain that only a handful of tools are required to put together a Jointworks armature, which by itself represents a tremendous savings over the kind of machinery needed to tool ball-and-socket armatures yourself.

But just as substantial is the savings in time. "It would take a pro two or three weeks to scratchbuild the kind of armature we're talking about, and that's in a fully-equipped shop. But with so-to-speak off-the-shelf components from The Joint-

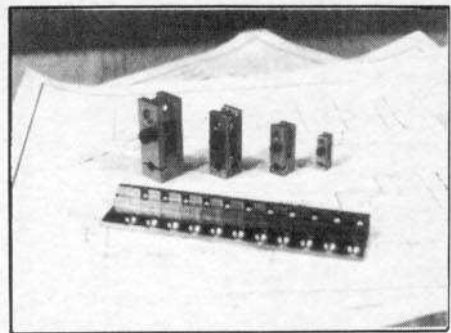

The tolerances of The Jointworks' ball-and-socket components are of a professional caliber, 1/10,000 of an inch. Machining is done on a computer-programmed, numerically-controlled mill.

works, you can put one together in one or two days. Same armature!" Hedge exclaims. Are you reading this, Ray?

Traditionally a man of some vision, Hedge speculates excitedly on the future of The Jointworks. "There's no question that video instruction will one day make the printed manual obsolete. I'm planning a videocassette that will not only tell but show the filmmaker how to put together a puppet, from inception to the final flourish of a paintbrush." Further down the line, and still in the planning stage, is a series of, for lack of a better name, Designer Puppets, professionally sculpted, to be made available in the form of pre-cast parts in foam rubber, which can be assembled around a Jointworks armature. "What I have in mind for the Designer Series," Hedge explains, "is a selection of puppet designs that represent the most commonly made puppets in fan circles. Tyrannosaurus Rex, for example. Everybody at one point or another makes a Tyrannosaurus Rex. With the Designer Series, they'll be able to make the best Tyrannosaurus Rex they ever saw!"

Hedge sees his company as the answer to many an exasperated prayer. "All you aspiring Harryhausens and Tippets out there," he kids, "now you don't have any more excuses." **CM**

*About the Author: Nick Seldon wanted to be Ray Harryhausen until he discovered writing. He has made miniatures for 1941 and One From The Heart. Now he is working on a novel that will be of interest to science fiction fans.*

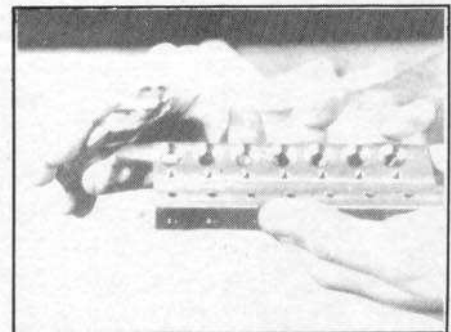

Sockets are milled with a precision ball end tool rather than a drill, assuring maximum, even tension characteristics. Because they're stainless steel, no annealing is needed, and they're easy to silver solder. Jointworks ball bearings are precision lapped.

# GRIP KIT

## X-ray Protection

SIMA Products Corporation has unveiled its new double-thick Super FilmShield pouches for protecting super-speed 1000 film from airport X-ray damage. SIMA will begin marketing Super FilmShield internationally in conjunction with Eastman Kodak's introduction of 1000 speed film. Minnesota Mining & Manufacturing (3M of St. Paul, MN) is also planning to market a 1000 speed film beginning this summer.

Extensive testing conducted by Kodak confirms that super-fast films are particularly susceptible to harm from X-ray radiation. For example, Kodak reports that their new ISO 1000 film is three-and-a-half times more sensitive to X-rays than ISO 400 film.

For ten years, SIMA has manufactured the "regular" FilmShield lead laminated pouch, which completely safeguards all films with an ISO rating under 1000 from X-ray penetration. The company will continue marketing this product.



Super FilmShield for super-speed 1000 film will retail for \$11.95; regular FilmShield carries an \$8.95 price tag. Both versions of the lead laminated pouch are identical in size—capable of holding up to 22 rolls of film or a loaded camera. The reusable FilmShield pouch should be stored flat when not traveling. Lead is subject to "fracturing"—a form of cracking—with continued use. A "fractured" or excessively wrinkled FilmShield pouch should be discarded and replaced so as to guarantee total protection for all film.

Because the new generation of super fast film is especially vulnerable to X-ray penetration, Kodak has taken special precautions to advise consumers about the hazard. In fact, a warning printed on both the Kodak 1000 film box and instruction sheet warns: "Protect from heat and X-rays." 3M is likewise considering a warning on its packaging.

Irwin Diamond, president of SIMA, applauds Kodak's X-ray warning, calling it a "responsible approach to a serious problem.

"It has been a long battle," he adds "but now virtually every recognized, responsible authority accepts the fact that airport X-ray screening can damage photographic film. They now agree that the problem is just as acute at U.S. airports as abroad—maybe more so."

Diamond and a group of highly respected photographic experts have spent nine years trying to convince the Federal Aviation Administration (FAA) that new U.S. airport signs should be posted which warn travelers: "Airport X-rays may damage unprocessed photographic film." Despite legal action, formal petitions and even an offer by the group to pay for the cost of new airport warning signs, the FAA has steadfastly refused to budge on the issue.

Several years ago, Canada became the first government to post airport signs urging extra caution due to the potential of film damage from X-ray screening. The sign change was brought about because Canadian government-sponsored research identified a significantly greater risk of damage when higher speed films were exposed to X-ray radiation.

This Canadian research is now being verified almost universally as faster speed films become more popular.

Diamond points out that the problem is particularly acute in some nations—including the United States. He notes:

"Many well-intentioned individuals recommended hand-inspection of carry-on luggage as a way of preventing film from being ruined by airport X-rays. However, they are probably unaware that a visual inspection is absolutely impossible to obtain in many nations—including Switzerland, France, Italy, Belgium, Russia and Denmark. Your right to visual inspection is 'iffy' at best in Japan.

"In the United States, there is a different, more irritating kind of problem—intimidation. Since the FAA insists that X-ray screening is film-safe, guards at airport security checkpoints attempt to dissuade anyone requesting a visual inspection of their camera equipment. This is nothing less than a form of coercion—which tends to humiliate travelers and discourage them from seeking visual inspection."

During 10 years of international use, FilmShield has been proven a reliable means of protecting all film from X-ray damage. Diamond warns, however, that there are still a handful of airports around the world—in Great Britain, Hong Kong, the Philippines, the U.S.S.R. and Bahrain—where special high dosage X-rays units are utilized for security. He advises that only hand inspection of camera gear will save film from damage at these few locations. Fortunately, he observes, 99 percent of the world's airports use lower dosage X-ray screening equipment; and, in fact, airports in Great Britain and the Philippines are switching to lower dose scan units. He emphasizes:

"Therefore, at the overwhelming majority of airports around the globe, FilmShield or Super FilmShield is all the protection you need to guarantee the safety of your film from X-ray degradation."

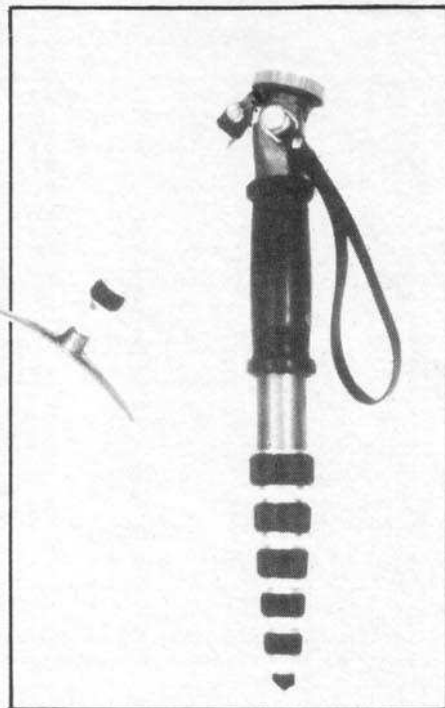

## Extra-short Monopod

Lightweight: 1 3/4 lbs. and short: 14", yet very sturdy even at full extension: 54", the new Gitzo Mini Mono Studex Super with soft grip, swivel head and shoulder support is ideally suited for 35mm, 2 1/4", 6 x 7cm, Super 8mm, lighter 16mm and video cameras. The extra solid tubular leg (1 1/4" diameter) is made of stressproof, hard tempered light metals, as used in airplanes. Five deeply anodized (1/10mm), corrosion proof, strong leg extensions glide smoothly, lock firmly on fiber sleeves, or nylon washers for wet conditions (no metal on metal), with soft cushioned locking rings, for easy, foolproof handling, without any binding—ever. The last section comes with standard hard rubber tip, or on request with metal spike and disc for icy or soft surfaces. The built-in swivel head offers both front and rear tilts plus side movement, and is supplemented by an extensible shoulder or chest support. The uncompromising heavy duty precision construction withstands the most rugged use and—like the 10 other Gitzo Monopods and the more than 100 Gitzo tripods for photo, cine/video—is covered by the full five year Gitzo warranty.

## New G.E. Lamps

Two new families of GE Quartzline tungsten halogen lamps for Fresnel spotlights used in studio, theatre and display lighting have been announced by the General Electric Company. They have longer life and/or higher light output, plus more constant color and light output throughout life than the incandescent lamps they can replace. The new medium prefocus base family (shown on the right) includes one 500-watt (ANSI Code BTL), two 750-watt (BTN and BTP) and one 1,000-watt (BTR) lamps. Each has a 2-3/16-inch light



center length and a "biplane" C-13D filament. These four new GE stage/studio lamps can be directly substituted in Fresnel spotlights for T-20 incandescent bulbs of equal wattage, with the same base and light center length. The second new family of GE stage/studio lamps (shown at left) has mogul pre-focus bases. It consists of two 1,000-watt (BVV and BVT) and one 2,000-watt lamps. The 1,000-watt lamps have "biplane" C-13D filaments; the 2,000-watt lamp has a "monoplane" C-13 filament. Each of the three lamps has a 3-15/16-inch light center length. They can be substituted directly in Fresnel spotlights for G-40 or G-48 incandescent bulbs of equal wattage, with the same base and light center length.

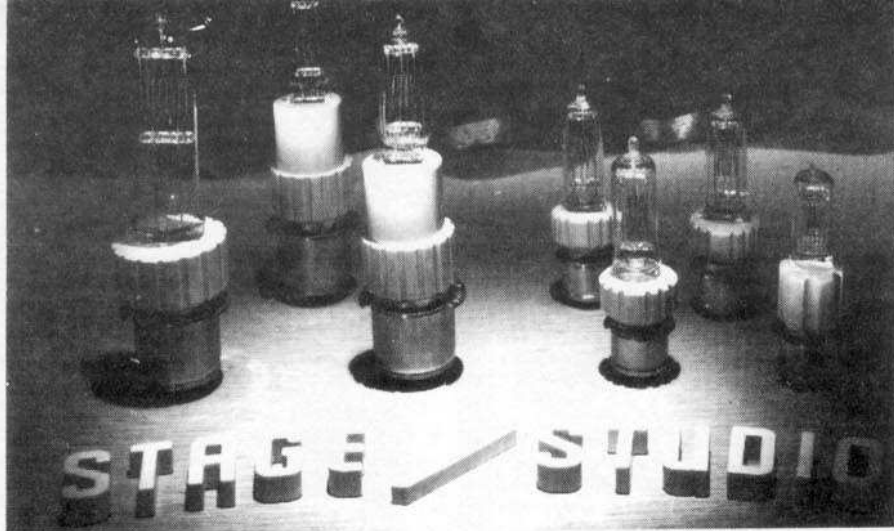

## New Fujicolor Film

Fuji Photo Film U.S.A., Inc. has announced the introduction of Fujicolor High Speed Negative Film AX, a high-sensitivity long-life film available in 35mm (Type 8512) and 16mm (Type 8522) formats. The new high speed film was developed by applying Fuji's advanced technology to further improve the performance characteristics achieved by the Oscar and Emmy Award-winning Fujicolor Negative Film A250.

An exclusive, revolutionary innovation applied to the technology of the AX film features a new cyan coupler which greatly extends color image life. Given recommended storage conditions (under 68°F, 40-50% relative humidity), AX negatives will be suitable for printing more than 100 years after processing.

formance characteristics as A250, such as natural color rendition, excellent suitability for mixed lighting sources and for fluorescent lights, while grain structure is actually greatly improved in shadow areas. These improvements make it possible to achieve even better color balance in dark areas.

In designing the new film, Fuji Film engineers examined such factors as contrast and sensitivity balance in three-layer emulsions. As a result of these studies, AX exhibits slightly higher contrast than the current A250.

AX, like the current Fujicolor negative films, is processed under Fuji-recommended processing conditions and is compatible with Eastman Kodak's process ECN-2 (ferricyanide bleach), and persulfate bleach.

Fujicolor High Speed Negative Film AX is manufactured under completely automated control by an integrated production system

## Lowel Softlight 2

The Softlight 2 is a significantly improved version of the famous Lowel Softlight 1500. Softlight 2 can use any combination of lamps up to two 1000 watt lamps to achieve a maximum of 2000 watts. And new double switching allows for various wattage combinations. Like its predecessor, the Softlight 2's Nomex shell comes off, and the whole unit folds in half, nearly flat. Three lights still fit into a portable case—with their barndoors. Top and bottom barndoors now have clips for attaching Lowel gels. A retrofit package is available to convert the earlier Softlight 1500 into the Softlight 2. The list price of the Softlight 2 is \$270.00, and kits start at \$460.00. For brochures on the new Softlight 2 and other Lowel equipment contact: Lowel-Light Manufacturing, Inc. 475 Tenth Ave., New York, N.Y. 10018 (212) 947-0950. West Coast: 3407 West Olive Ave., Burbank, California 91505 (213) 846-7740. *CM*



Fujicolor High Speed Negative Film AX has an Exposure Index (E.I.) rating of 320 in tungsten light and 200 in daylight with a Fuji LBA12 filter or a Kodak Daylight Filter No. 85.

Furthermore, if shooting under adverse lighting conditions requires even higher sensitivity, the E.I. rating of AX can be doubled by forced processing with virtually no change in the color balance.

AX film exhibits the same excellent per-

assuring uniform batch-to-batch quality.

Deliveries of 35mm (Type 8512) Fujicolor AX will begin in April. A delivery date for the 16mm format (Type 8522) will be announced shortly.

Fujicolor motion picture film has been designated as the "Official Film of the Los Angeles 1984 Olympics" and will be used to shoot the official documentary on the Games to be produced by the Los Angeles Olympic Organizing Committee.



# BOOKS



## PRESERVATION!

Protect your precious copies of CINEMAGIC, while keeping them on hand for easy reference in custom-crafted leatherette file cases or magazine binders embossed in gold with the CINEMAGIC logo. These handsome cases enable you to slip your copies of CINEMAGIC in-and-out individually, while the metal rod binders hold your copies of CINEMAGIC together, intact, like a large book, allowing you to leaf through issue after issue in chronological order. Each binder or case holds two year's issues!

**Library Cases:** \$5.95 each, 3 for \$17.00 & 6 for \$30.00 Postpaid.

**Binders:** \$7.50 each, 3 for \$21.75 and 6 for \$42.00 Postpaid.

**U.S.A. ORDERS ONLY**—Satisfaction guaranteed or money gladly refunded. Please allow 4 to 6 weeks for delivery.

Mail order to and make checks payable to: Jesse Jones Box Corp., P.O. Box 5120, Phila., PA 19141.

**Foreign Orders:** Add \$2.50 per unit for additional postage and handling outside the U.S.A. Prepayment must be in US funds only.

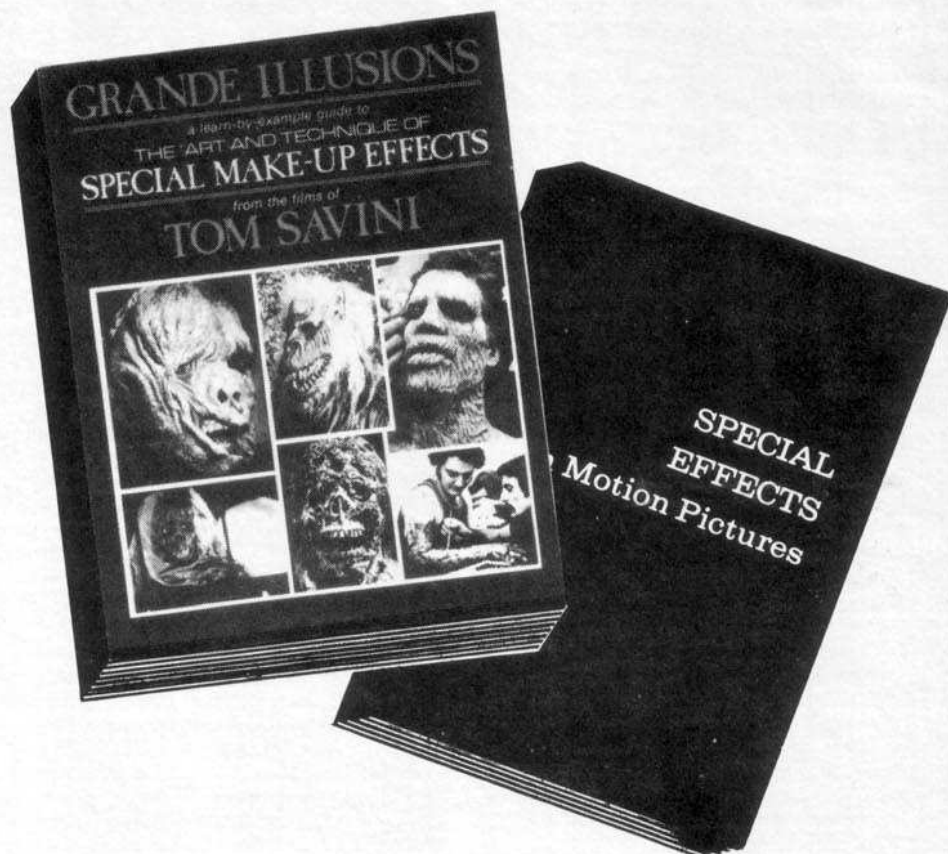

## SUBSCRIBER SERVICES

Missing copies? Moving? Renewals? Receiving duplicate issues? Questions about your subscription? Write directly to:

### CINEMAGIC

Subscriber Services,  
P.O. Box 142  
Mt. Morris,  
IL 61054

### NEW SUBSCRIBERS ONLY:

Do not send money and order to the above address. See subscription ad elsewhere in this issue.

Label Goes Here

Subscription inquiries addressed to the editorial offices will only delay your request.

NAME \_\_\_\_\_

ADDRESS \_\_\_\_\_

CITY \_\_\_\_\_ STATE \_\_\_\_\_ ZIP \_\_\_\_\_

**Grande Illusions.** By Tom Savini. Imagine, Inc., Pittsburgh, PA. 8½" x 10¼." 136 pages. \$12.95.

Tom Savini is one of the most successful special effects makeup artists of recent years. The films for which he has created horrifying effects include George Romero's *Martin*, *Dawn of the Dead* and the recent *Creepshow*. He's also responsible for the gruesome effects in *Friday the 13th*, as well as several other horror films including *The Eyes of a Stranger*, *The Burning*, *Maniac*, *The Prowler* and several others. In his new book, *Grande Illusions*, he reveals with graphic photos and informative writing how he created the special makeup effects for many of these films. *Grande Illusions* deserves the attention of every budding makeup artist and every filmmaker who wants to learn how makeup effects are created.

In addition to showing how he created specific makeup effects for the many films he's worked on, Savini divulges the standard techniques of the makeup artist's craft. The basic skills of pre-production sketching, making a lifecast of an actor's head, casting teeth and fangs and adding hair to latex appliances are covered thoroughly. There is even in-depth instruction on how to mix

and cure R&D foam latex by master makeup artist Dick Smith. Many of the specific makeups that Mr. Savini features in this book will inspire the reader to create his own original designs.

Some of the most fascinating makeup revelations come in Savini's description of the steps he took to create the "Fluffy" creature for *Creepshow*. These same techniques can be applied to creating any other alien creature you can imagine.

*Grande Illusions* is a beautifully designed book. There is plenty of color, much of it blood red. Some of the makeup creations depicted are quite gruesome, and you may not want your grandmother to discover you absorbed in studying how to effect a shotgun wound to the face or a throat slashing, but if you're into gore, you'll find plenty of it here. The gore is so graphically depicted in *Grande Illusions*, that those with weak stomachs should be forewarned. (Not too many makeup artists have weak stomachs.) *Grande Illusions* is for makeup artists and those who can appreciate a makeup artist's craft, no matter how gruesome it may get. Tom Savini, one of his generation's foremost makeup artists, has written one of the finest books available on the art of special effects makeup.

**Special Effects in Motion Pictures.**  
By Frank P. Clark. S.M.P.T.E., New York,  
© 1966, 238 pages, paperback

This basic text published by the Society of Motion Picture and Television Engineers, Inc. has gone through a couple of printings, since it was first published in 1966. Author Clark has based this book on a thesis written for a degree in cinema at USC. This SMPTE edition is an expanded and illustrated edition of that 1963 thesis.

The book begins with a brief history of the development and application of

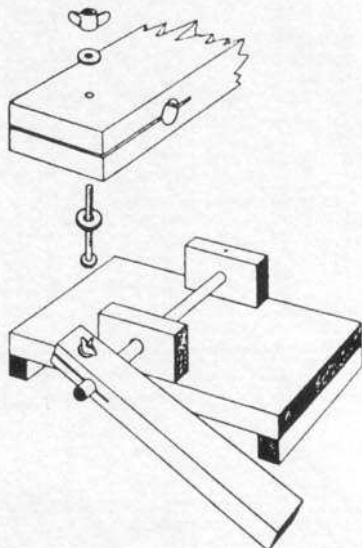

special effects covering the full range of photographic mechanical and atmospheric effects. The book's ten chapters are capped with a bibliography of useful articles and information sources, a manufacturer's address list and an index. Unfortunately, a good many of the manufacturers and companies listed in the appendix have long since gone out of business, but it can be used as a starting point.

Quite a number of the specific techniques in the book are not current practice, though many of the basic principles are still in use, even in this age of computerized motion control. More than a few methods however, will be of interest to CINEMAGIC readers as they do not require expensive equipment and are more dependent on the skill and imagination of the filmmaker.

In addition to the usual chapters on in-camera effects and opticals are chapters covering a number of pyrotechnic techniques, sound effects and a chapter rather ominously titled "Shooting." The latter refers to guns and knives, rather than camera stock. Here, too, the information is over 20 years out of date, but many of the techniques are still in use and it will give you a fair idea of how special effects weapons are handled.

This book may be directly ordered from the SMPTE at 862 Scarsdale Avenue, Scarsdale, NY 10583. Write for current price and shipping information. *CM*

## Make Magical Special Effects

WITH ANY SUPER 8 CAMERA, SOUND OR SILENT  
AND NO MODIFICATIONS!

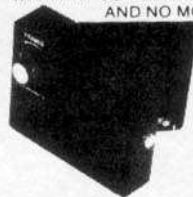

### CRAVEN BACKWIND

- Lifetime Guarantee
- Solid Metal
- Frame Counter
- Backwind 300 Frames
- Takes Sound and Silent Film

### STARSHIPS & LAZERS, GHOSTS & MONSTERS...

... A ship zooming through space ... People doing things ... Now superimpose the titles while the action continues. This way you give your movies an exciting new professional touch, and you can do it easily and reliably with the Craven Super 8 Backwind. It works for any super 8 cartridge loading camera, regardless of price or model. You get a genuine backwind, superimpose facility, not limited to just 90 frames or so (even the most expensive camera can't do this!) Compact, ruggedly engineered — No mods. of any kind to your camera. Comes with easy to understand, detailed instructions showing you how to make space shots, laser beams, ghost effects, multiple images, dissolves and much much more. The Craven Backwind costs only **\$52.95**

### SEND FOR INFORMATION PACK

Halmar is famous for its conscientious and friendly service to movie people. Our products are fully guaranteed and almost always dispatched the same day we receive the order. You owe it to yourself to get full details of the Halmar range of movie accessories. Your name and address with \$2.00 will bring you an informative, and interesting information pack which includes many unusual items and our famous FOCUS DISC. Use it and you'll get pin sharp movies every time. **GUARANTEED!**

### HOW TO ORDER

Simply send a money order or cheque and we'll have your backwind on its way by return, or better yet call us **RIGHT NOW** at 1-416-356-6865 with your Visa or Mastercard number and we'll fill your **ORDER TODAY!**

The Specialists You Can Trust

**Halmar Enterprises—CM**  
P.O. Box 474, Lewiston  
New York, 14092, U.S.A.

# CineMagic MARKETPLACE

For as little as \$15.00 you can reach all our special effects fans.  
**DEADLINE:** CINEMAGIC #21 in our office by May 30th.  
CINEMAGIC #22 in our office by July 13th.  
**BASIC RATE:** \$5.00 per line. Limit—45 characters per line. Minimum three lines. Punctuation, symbols and spaces count as characters. Small display ads—\$40.00 per column inch (camera-ready ONLY!!)  
**HEADLINE:** First line only—Word(s) of your choice (underline them) will be printed in **BOLD CAPS**.

**CATEGORY:** PLEASE BE SURE TO INDICATE THE CATEGORY YOU WANT TO BE LISTED UNDER.

**PAYMENT:** Cash, check, or money order must accompany ad order (checks payable to Starlog Press, Inc.)

**MAIL TO:** CINEMAGIC, c/o Starlog Press, Inc.  
475 Park Avenue South  
New York, NY 10016

### MERCHANDISE

**SPACE SLIDES** For FRONT Or REAR PROJECTION. Imagine beautiful planets, galaxies, nebulas, etc. in your Super-8 films! Set of ten—\$9.95 to: SLIDES, Sooy Lane, Absecon, NJ 08201

### SPECIAL EFFECTS MAKE-UP

The Make-Up Place: Large supply of special effects and prosthetics make-up, foam latex, Mehron, Kryolan, Ben Nye products. Send for free price list. The Make-Up Place, 100 Boylston St., Boston, MA 02116

### RECORDS

1,000,000 **SOUNDTRACK LPS!** SF/HORROR Catalog-\$1. RTSCM, Box 10687, Costa Mesa, CA 92627. ST Valueguide—\$5

### SERVICES

**CUSTOM MADE SPECIAL EFFECTS MODELS.** If you need stop-motion models, spaceships and vehicles, masks, cable controlled creatures and the like for your special effects photography, then send your designs to us. We will turn your ideas into 3-D. Free estimates. Paul Mejias, 136 Orchard St., Eliz., NJ 07208

**Magnetic Sound Stripping.** Finest magnetic stripping. Weberling lamination Super-8/8mm 6¢ per ft., 8¢ per ft. with balance stripe. Rush Service. MAGNESTRIP, 333 Aycrigg Ave., Passaic, NJ 07055. (201) 733-4633.

**STOP MOTION MODELS** \* Custom armatures and components \* Sculpture and foam casting services. Send for information & prices. Ken Brilliant, 24 Sanford Rd., East Brunswick, NJ 08816

## ★ SCRIPT-CITY ★

Film & T.V. Scripts—Largest Selection—  
—Lowest Prices!!! Huge Sci-Fi & Horror  
Collections. Send for **FREE** 22 page  
catalog...Receive **FREE** introductory offer!  
Script-City, 1765 N. Highland  
#760CM, Hollywood, CA. 90028

THE BUSINESS END OF THE GORN SHIP  
BLUEPRINTS. TWO BIG SHEETS GIVE YOU  
THE INFORMATION YOU NEED TO KNOW ABOUT THIS  
MEAN LEAN MACHINE. \$4.95 POST PAID.....

STARLOG PRESS  
475 Park Avenue South ★ New York, New York ★ 10016

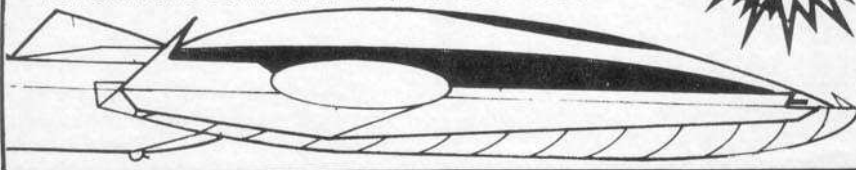

# The DREAM SCREEN Effect

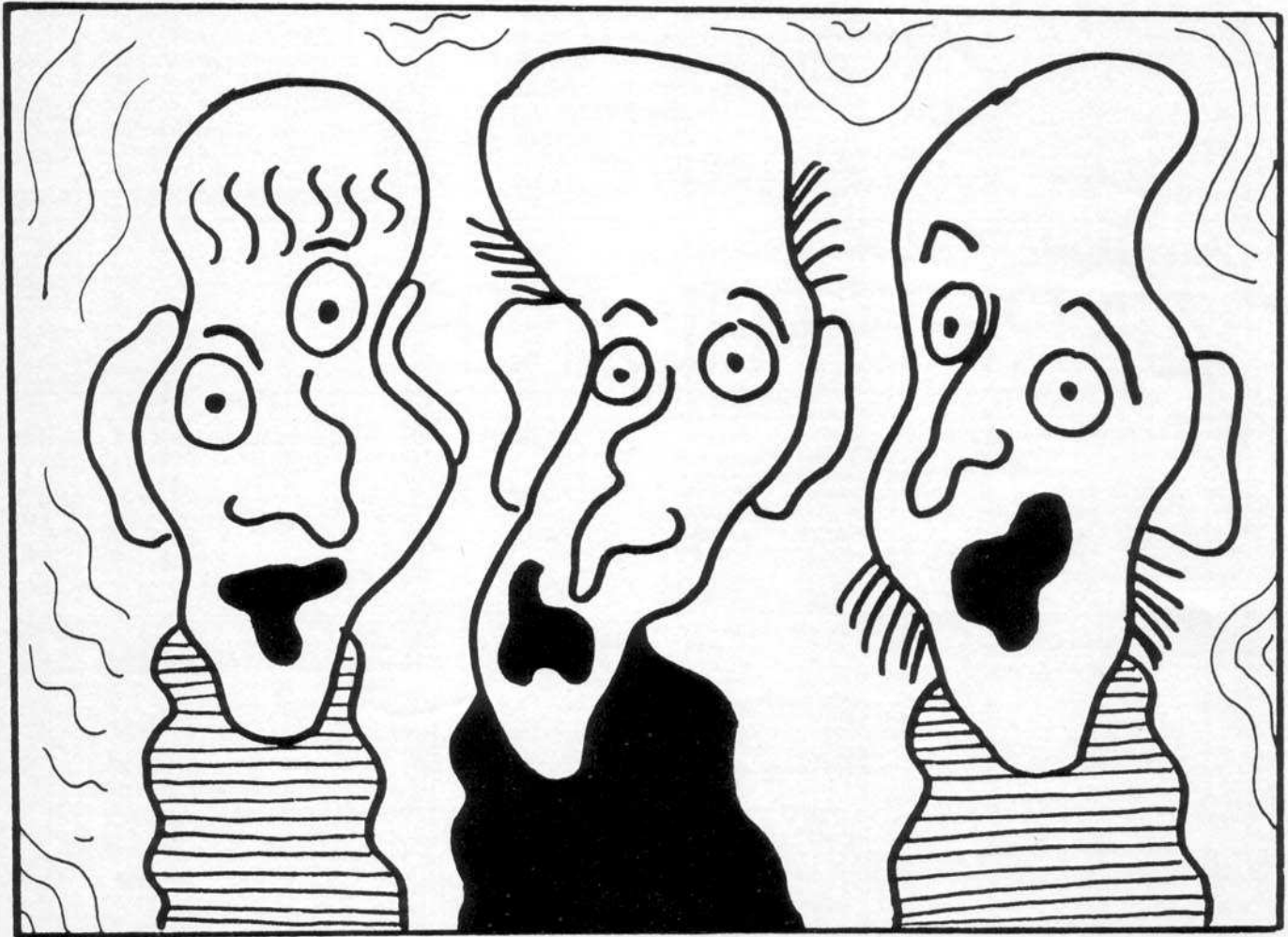

ART: JACK IMES, JR.

By JACK IMES, JR.

**I**f you have a script that calls for a dream scene, fantasy shot, or a mirage-like figure, here's a handy device that may be just the trick to get the right "look" to the shot. The device (I call it

a "dream screen") is simply a small sheet of clear plastic that has been heated and twisted. The warped sheet is then held in front of the camera lens to create a distortion of the scene. The image seen in the

viewfinder appears to magically bend, shift, and stretch as if in a dream world. The dream-like effect can be further exaggerated by using color acetate filters with the screen device.

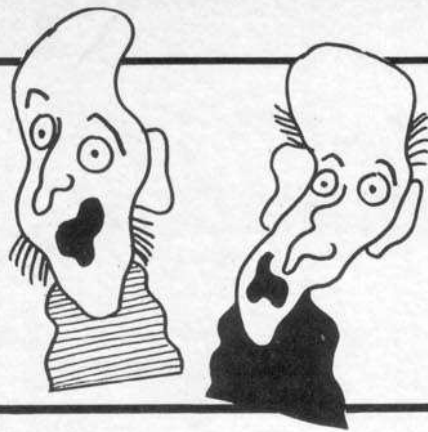

Here's what you will need to make your screen:

**Materials:**

Clear acrylic sheet, 6-by-8 inches, 3/32" thick.  
Aluminum foil.  
(The plastic sheet is available at hobby or hardware stores.)

**Tools:**

Two oven gloves    Kitchen oven (with rack)  
Cookie sheet        Kitchen sink

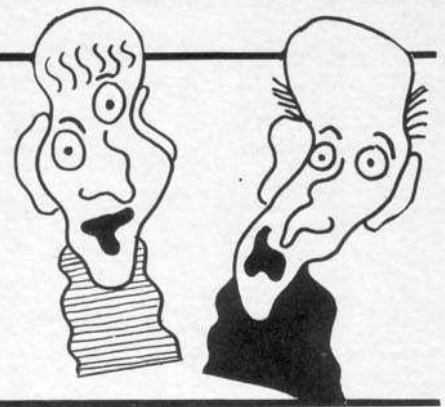

**STEP 1:** Place the cookie sheet on the center rack of the oven. Set the oven temperature to 250-degrees F. Allow five minutes to pass before going to **Step 2**. This will give time for the oven to heat properly.

**STEP 5:** Use the oven gloves to open the oven door and remove the cookie sheet. Place the hot cookie sheet on the stove top. Lift the aluminum foil by one end flap and carefully tip the warm plastic into your other glove. The plastic cools rapidly so you must work quickly. Hold the warm plastic sheet with both gloves as if you were holding an open book. Flex the sheet by gently twisting your hands in opposite directions. The soft plastic should bend easily so be careful not to bend too drastically. The idea is to form several ripples in the sheet, so work as quickly as you can.

**STEP 2:** Place the plastic sheet on a large piece of aluminum foil. Fold up the ends of the foil to make two handle flaps. These flaps will be useful later for handling the sheet.

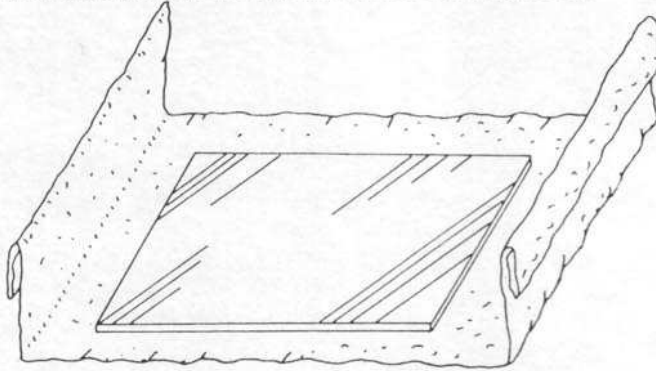

**STEP 2**

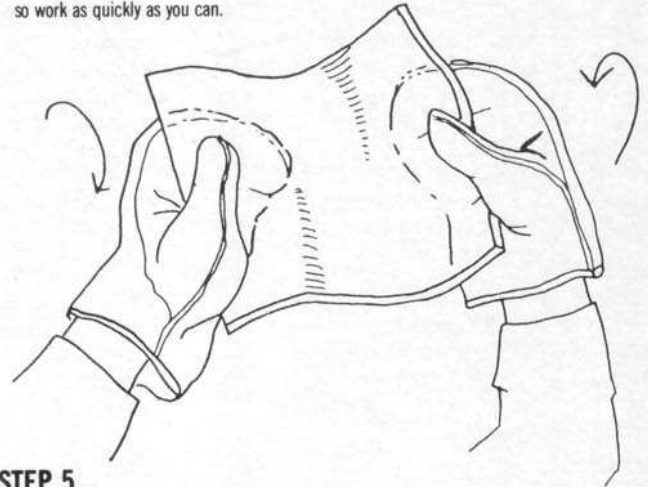

**STEP 5**

**STEP 3:** Open the oven door. Place aluminum foil tray and plastic on the cookie sheet. Close the door and wait five minutes for the plastic to soften.

**STEP 6:** When the plastic sheet has been deformed in several areas, place it under the running water to quickly cool the plastic into shape. Later you can dry it with a soft cloth which won't scratch or mar the plastic surface. Now put the sheet in front of your camera lens and commit your dreams to film.

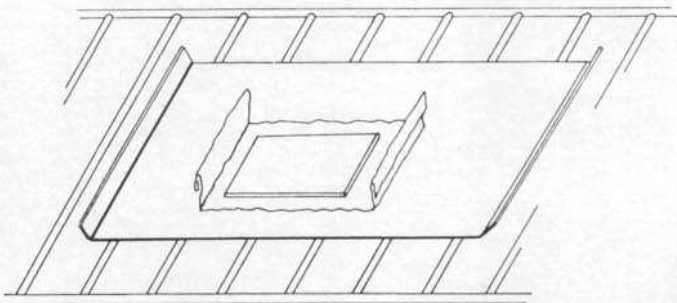

**STEP 3**

**PHOTOGRAPHY:** The camera can be hand-held or mounted on a tripod when shooting with the dream screen. Set the lens to the telephoto position and look through the viewfinder. With your free hand, hold the dream screen close to and in front of the lens. Move it slowly in a circular path across the field-of-view. The image will appear deformed as the screen ripples refract the light in odd patterns. The "dream" effect can be heightened by a red or blue filter placed on the camera lens. *CM*

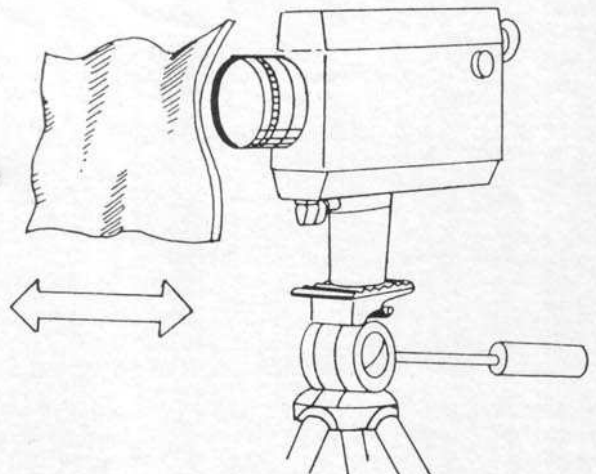

**STEP 4:** Turn on the sink faucet and adjust the water to a lukewarm temperature. (Cold water could crack the plastic sheet.) Reduce the water flow to a thin stream.

# Masks and Makeups that *Move*

*Special effects artist John Dods reveals an inexpensive technique for creating professional-quality articulated full head masks.*

By JOHN DODS

**T**he mask moved. I had seen the effect before in films like *An American Werewolf in London*, *The Incredible Shrinking Woman* (Sidney the gorilla), *Creepshow*, and *ET*—masks that moved—rubber faces that changed shape. Makeup artist Arnold Gargiulo was

showing me how it was done. As Arnold pulled on a thin wire cable the mask's upper lip moved back to reveal shiny pointed teeth. When he pulled another line the lower lip curled into a snarl. The ears wiggled.

Then, Arnold showed me how to do

“bladder effects”—that’s the swelling and bulging of facial areas that signals a pending transformation in recent films like *Altered States* and *The Howling*. Amid what may be the most important series of innovations in the field of makeup since foam rubber—faces are coming to life. Here are the step by step basics of this new makeup mobility—a beginner’s introduction to animating fantastic faces.



Arnold Gargiulo and his handiwork. Shown here are two wearable masks (one under construction) with faces that move. Note the control cables and the goalie mask construction of the uncompleted mask on the right.

## MECHANICAL MASKS

These are the hardware and materials you need to make an over the head mask with facial change capabilities like the one pictured:

- Hockey goalie mask—large size “preferable” (ice hockey type)
- Hot melt electric glue gun, and refill glue sticks
- Flexible plastic tubing: 12 feet of ¼ inch and 6 feet of ½ inch.
- Flexible plastic coated telephone wire—about 22 feet.
- Assorted hinges: curtain rod type—8 or more.
- Wire end clips—8 or more.
- Assorted small nuts and bolts (used to attach hinges).
- Acrylic teeth and gums.
- Rubber tongue tip and black back drop.
- Plastic eye covers (or just eyelids).
- Artificial fur hood large enough to cover entire head.
- Dremel motor tool and assorted bits; a conventional electric hand drill can be used with a bit more difficulty.
- Miscellaneous: Liquid latex, oil (lubricant), white glue, 1 small spring (about 1 inch x ⅛ inch diameter), crepe hair.

These directions will guide you through the construction of a mask similar to the one illustrated—a creature of basically humanoid physiognomy. Some adaptations will be necessary if your creation doesn’t sport the usual arrangement of eyes, ears, nose, and mouth.

## MAKING THE MASK

**Step 1:** This article will not detail the technique of mask making or rubber prosthetic fabrication. The rubber face of Arnold's mask was made using a slush mold technique; this procedure is covered in careful detail by Craig Reardon in CINEMAGIC #12; refer to this excellent article for full coverage of this subject.

Briefly, what Arnold did was to sculpt the desired pieces onto a plaster bust (of average proportions) using clay. The clay was covered with Hydrocal casting material to produce molds. The negative impressions in the molds were coated with liquid latex to produce the rubber ape face. More recently Arnold has been using

foam rubber for this type of work. Latex is easier to work with but foam rubber is softer and more flexible; it's the professional standard for this type of work.

Information on making and applying foam prosthetics can be found in the books *Filmmagic* (available from Don Dohler, 12 Moray Ct., Baltimore, Md. 21236) and Richard Corson's excellent *Stage Makeup* (available through Paramount Theatrical Supply, 575 8th Ave., N.Y., N.Y. 10018). Arnold particularly recommends George Bau Foam Rubber for mechanical masks (order from Windsor Hills Makeup Lab, 5226 Maymont Dr., Los Angeles, CA 90043) but it is only available in minimum quantities of 5 gallons! R&D Foam Latex is not as flexible

as Bau foam but it is a good product and available in a 1 gallon size (from R&D Latex Corp., 5901 Telegraph Rd., Los Angeles, CA 90002).

If you want to make a mechanical mask in the simplest possible way and avoid the complications of molding and casting altogether—an ordinary Halloween mask can be a passable substitute for one of your own making. The cheaper masks will be the most useful since they tend to be made of thinner, more flexible material which will respond more readily to cable manipulations than a Don Post \$80.00 heavy gauge type. Get the \$10.00 mask and if it's *too* thin add some reinforcement with liquid latex applied to the mask's interior.



**Left:** Makeup artist Tom Savini calls hot glue "one of the greatest inventions since the tooth brush." Here, Arnold Gargiulo uses it to affix the ends of the cables to the hinges that will control the facial movement of the mask. **Above Left:** Arnold pulls on the cable that controls the movement of one of the eyebrows to check the response before proceeding any further. **Above:** The chin section of the hockey goalie mask is padded with foam rubber to ensure a snug fit and a little comfort for the wearer.

## PREPARING THE SUBSTRUCTURE

**Step 2:** Note accompanying photos and drill a hole in the hockey mask wherever a hinge is to be attached; drill one hole for each eyebrow, two for the upper lip area, two for the lower lip area, one for each ear, two for the jaw, and two for the jaw spring.

**Step 3:** Saw the hockey mask all the way through at the jawline, thus making the jaw a separate unit.

**Step 4:** Attach the hinges: The type of hinge that Arnold has found useful is a kind used to hang up curtain rods; these are the right size and come with a convenient hole at the end to accommodate the small bolt that will be used to fasten the hinge to the hockey mask. Ordinary nuts can be used but a "stop nut" is better, as this type will not loosen or turn from the position you set it in (slightly loose preferably).

**Step 5:** On the end of each hinge you must glue a "wire end clip" using the hot melt glue gun (Arnold uses the glue gun throughout the process as a quick way of fastening things). The movement control cables will be fastened to these clips later.

**Step 6:** Attach the flexible tubing to the mask. You will need two, three-foot pieces of 1/2 inch tubing and four three-foot pieces of 1/4 inch tubing to duplicate Arnold's efforts. Note the photos for correct placement. Arnold attaches these tubes at several points along the path of the tubes using the glue gun.

**Step 7:** Push the control cables (telephone wire) through the tubing. A little lubrication (mineral oil, castor oil, or Vaseline) will facilitate this process. The cable ends that emerge are glued to the wire end clips with the glue gun. You can now test the movement of the hinges by simply pushing and pulling the cables while firmly holding the tubing.

**Step 8:** This is a good time to attach the

false teeth, gums, and tongue, again using the glue gun. These components might be made of latex rubber—having been sculpted in clay and cast in plaster—or they might be made of hard plastic using techniques described by Craig Reardon in CINEMAGIC #12 or by myself in CINEMAGIC #18 ("Making Monsters"). A black velvet cloth must also be applied to block the mask wearer's features that would otherwise be visible through the large mouth cavity. This completes the understructure of the mask.

**Step 9:** The rubber face is attached in these sections: chin, upper muzzle/nose, cheek/eyelids, forehead/brows, and ears. The rubber *must* be attached with the cables pushed either half or all the way in. As each piece is hot glued into place, manipulate the connecting cable to gauge the effect and make sure the effect is satisfactory.

**Step 10:** Glue down the edges of the rubber pieces, again frequently checking



A rear view of the hockey goalie mask with the tubes and control cables attached. A little lubrication (mineral oil, castor oil or vaseline) will facilitate the process of pushing the control cables through the flexible plastic tubing.



All of the control cables have been hot glued into place and Arnold has begun to fix the latex mask pieces to the hinges. The pieces *must* be attached with the cables pushed either half or all the way in. All the pieces are hot glued into place.



Arnold checks the movement of a lower lip control hinge before hot gluing the rubber mask piece into place. The false teeth, gums and tongue are already in place.



The rubber mask pieces are all in place and the moveable face now awaits the application of fur. The fur is crepe hair or "fur cloth" attached with hot glue.

PHOTO: JOHN DOOS





Arnold checks the movement of the upper lip on the mask. This photo shows the normal position, with no tension on the plastic coated telephone wire control cable.



As Arnold pulls on the control cable, the mask's upper lip curls into a snarl. The edges of the mask pieces are later concealed with liquid latex and tissue paper layers.

the effect of cable movements. If you are using latex rubber mask pieces you may find that they have a tendency to "cave in" (not hold their shape in the desired way). This problem can be corrected by stuffing the problem areas with thin foam rubber sheeting or with shredded foam.

**Step 11:** To conceal the edges of the rubber pieces, cover them over with liquid latex and tissue paper, using as many layers as necessary to get it to look right. This is force dried with a hair dryer and painted with an acrylic (80%), latex (20%) mixture. Arnold uses theatrical makeup to further refine the mask's appearance.

**Step 12:** Crepe hair or "fur cloth" artificial fur can be attached using the glue gun.

Experiment with different kinds of cables. Arnold has recently used hardware store braided "picture hanging wire" successfully as well as the control cable wire for miniature motor-powered airplanes (look for it in hobby stores). Tom Savini told me that this is what he used for the cable-controlled inhabitants of *Creepshow*.

Arnold notes that the hardness of the cable sheathing makes a difference. He has found that a stiffer tubing such as polyurethane works better to insure smooth cable movement than does vinyl tubing. [Teflon tubing is also popular. Ed.]

By means of simple mechanics, Arnold makes masks *move*; using a system of controlled airflow he brings makeup into motion as well.

### BLADDER EFFECTS

The forehead bulges—the cheeks swell and recede. Moving where faces are not supposed to move, the skin seems to contain a force trying to find a way out.

If you saw *The Howling* you will be likely to remember this action as the prelude to a young man's on-screen transformation into a werewolf. Using techniques pioneered by makeup innovator Dick Smith (and utilized by Smith in *Altered States*), *The Howling's* Rob Bottin created a series of inflatable "bladders" which were attached to the actor's face and concealed under the foam rubber appliances. When the bladders were inflated with air pumped through thin plastic tubing the foam skin would swell—pushed outwards by the enlarging bladders—and then contract as the air was released.

Arnold reports that Dick Smith uses a material called "Smooth-on" to create super thin bladders of any desired size and configuration (order PMC 724 Urethane Elastomer and compounds for curing from Smooth-on, 1000 Valley Road, Gillette, N.J. 07933). We are going to defer the details of making customized bladders to a future issue of CINEMAGIC and

describe a simplified method worked out by Arnold. Balloons are the bladders here and they work.

Here are the materials you need to execute the makeup pictured:

- 1) assorted sized party balloons;
  - 2) miniature aquarium airline tubing;
  - 3) regular size aquarium airline tubing;
  - 4) adapters to connect miniature tubing to regular size tubing;
  - 5) small rubber bands;
  - 6) adhesive tape;
  - 7) ear syringes with flexible nozzle;
  - 8) foam rubber prosthetics.
- The aquarium tubing is available through most pet supply stores—ear syringes from drug stores.

### BLADDER PREPARATION

Choose a size balloon that suits your purpose and insert a three-inch length of miniature airline tubing into the neck of the balloon. Seal the joint with a small rubber band and masking tape. If it seems necessary—seal further with latex rubber or five minute epoxy. Connect the larger (regular size) aquarium tubing to the miniature tubing by means of adapters made for this purpose. Make the total length of the connected tubes long enough to allow inflation from a convenient spot outside of camera range.

The air will be pumped to the balloons by means of a small hand pump connected to the end of each tube. A small ear

syringe works very well. The flexible neck of the syringe can be cut with scissors as desired to facilitate the best connection to the tube. The more neck you snip off, the larger the interior channel becomes. If you snip off the right amount, your aquarium tubing will fit snugly into it. Keep in mind — or you may go crazy—that absolutely air-tight connections are not usually essential. Unless you plan to inflate and hold for several seconds or more, a slow air leak is not likely to be evident.

After you decide where you want the balloons placed, attach them to the actor's face using spirit gum and masking tape. Attach *only* the end of the balloon where the tube is connected. Leave the rest as free as possible. Do not proceed with the makeup until you're sure that the balloons and tubing are firmly anchored.

Thin foam rubber prosthetics are applied directly over the bladders. The larger part of creating a bladder makeup is the creation of the prosthetics that cover the bladders.

Some compromise must be found in determining the thickness of the appliances. If they are too thin the bulk of the balloons and connecting tubes might begin to show through as an evident bulge on the surface of the rubber skin. Clearly, the thinner the tube and the less bulky its connecting point to the balloon—the more successful the makeup will be.

Arnold suggests concealing any tell-tale bumps on the foam face with a stubble beard made of crepe hair: if this makes sense on the face you are creating.

The bladders should be tested at various points during the application of the foam pieces so you can see how it's all working out while there's still time to make adjustments with the balloons.

After the edges of the appliances are stuck in place with spirit gum they are covered with liquid latex or duo surgical adhesive and force dried with a hair dryer. Then, the makeup is applied. The tubes that may be visible as they exit the

makeup must be concealed by some combination of strategic placement: a wig, careful lighting, and camera placement.

If you can't resist the temptation of playing the game of "How much can I inflate the bladder before something happens" — expect the worst. It's better to wait till your masterpiece is safely recorded on film before going to these extremes.

Times change. Makeup once meant nose putty and grease-paint; strange it should come to include aquarium tubing and party balloons. It used to be that a mask would just sit on your face—its expression permanently frozen. Stop-motion artists have been animating *their* creations since silent movie days. Makeup artist are finally catching up. Dick Smith, Carlo Rambaldi, Rick Baker, Rob Bottin, Tom Savini, and Arnold Garguilo are cinemagicians bringing faces to life. Today masks change shape. Now makeups *move*. CM

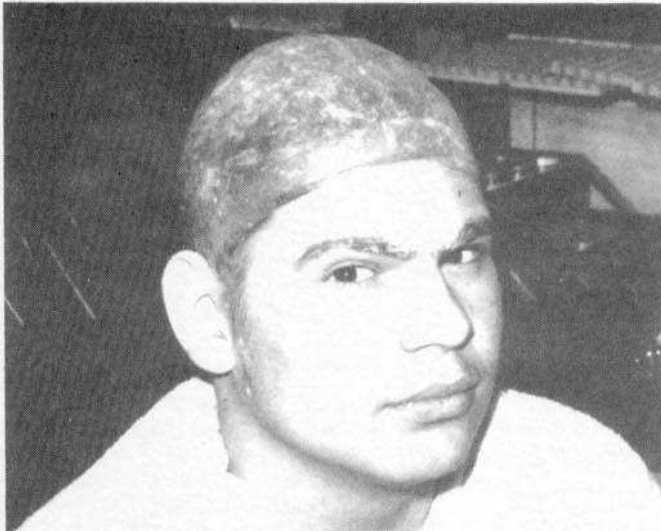

A bald cap has been applied to the subject's head to protect his hair and ready him for the process of applying "bladder effects" thin foam rubber prosthetics.



"Bladders"—in this case ordinary party balloons—are applied to the subject's face. The balloons are attached by means of spirit gum and masking tape.

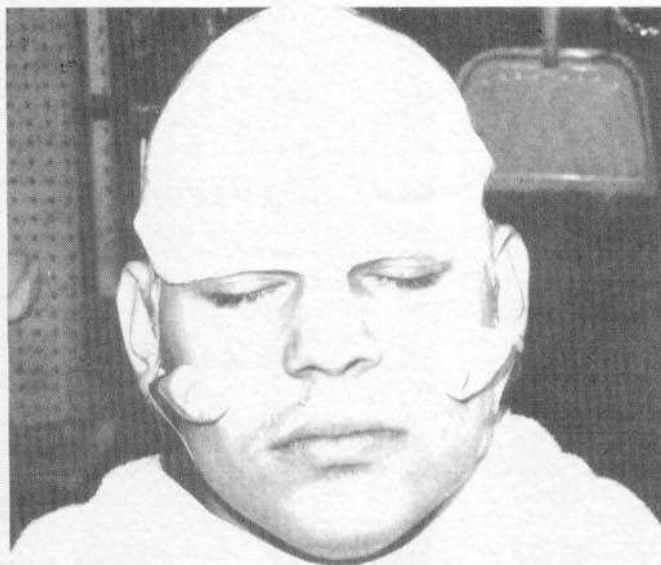

The forehead foam appliance is attached, covering the three forehead balloon bladders. Bladders should be tested at various stages of the application.

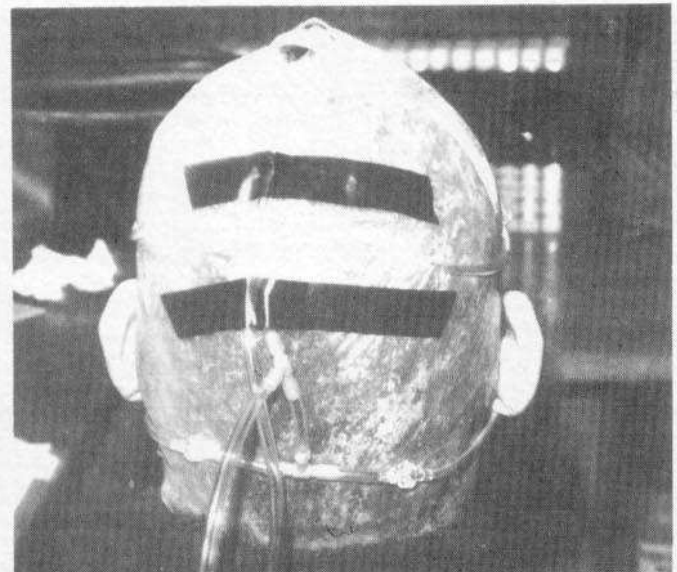

Electrician's tape holds the tubing in place at the back of the subject's head. Note the aquarium tubing connectors. Both miniature and regular tubing is used.

**Right:** Gabe Bartelos, one of Arnold's makeup associates, poses with Arnold's latest cable controlled, articulated full head mask. The area around Bartelos' eyes has been darkened so it won't be visible through the eye sockets of the mask. The mask is made in sections and hot glued onto a specially modified hockey goalie mask. Artificial fur covers the rest of the wearer's head. **Below:** Arnold puts the finishing touches on his latest creation, being worn by Gabe Bartelos.

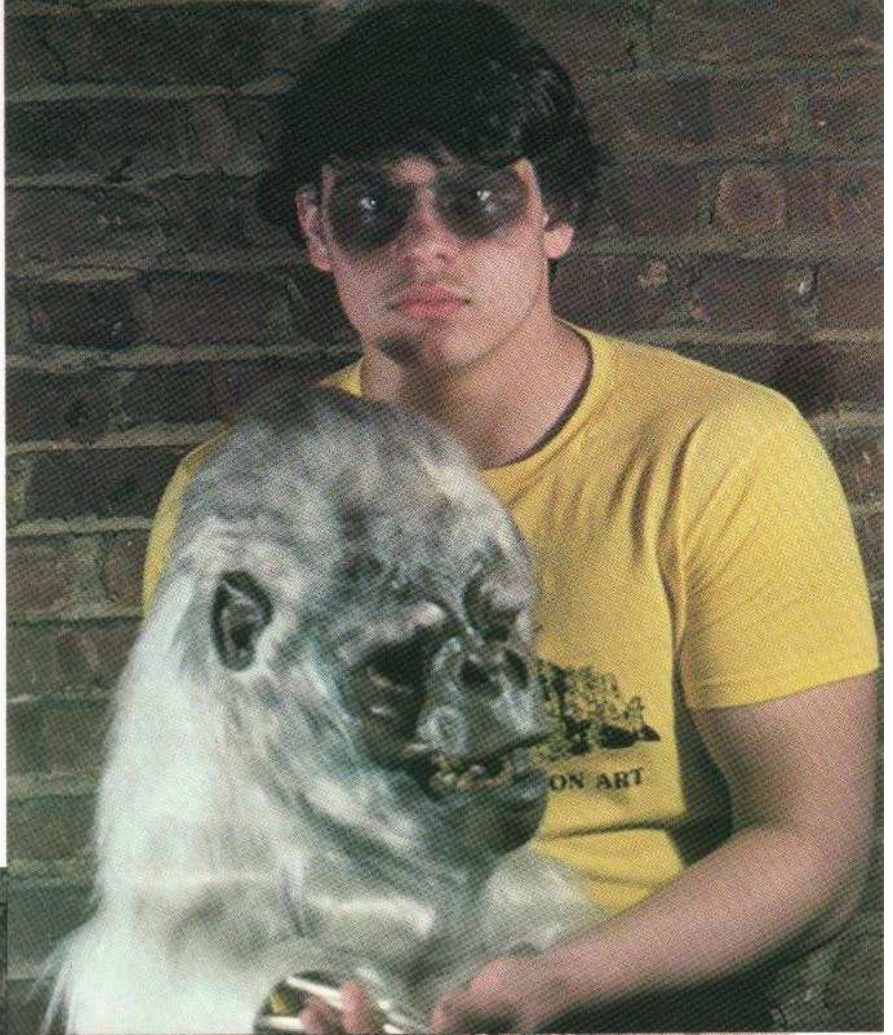

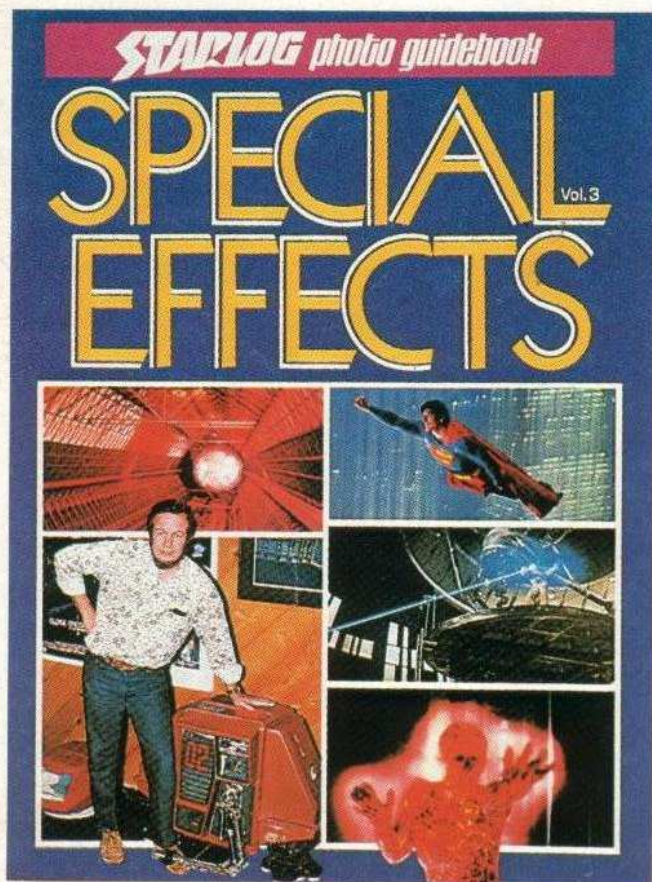

## NEW!

### HIGH-TECH FILMMAKING!

Just published, this newest volume in the STARLOG Photo Guidebook series on Special Effects takes you on a trip into the gleaming world of modern film wonders—the technologies that create Hollywood's special effects for science fiction, horror and fantasy movies. In this exciting book you'll read about computer animation, robot cameras and new optical processes. SPECIAL EFFECTS, Vol. 3 lets you visit the shops of many of the technical artists who make the "impossible" their everyday job. Lavishly illustrated with page after page of photos (many in full color) this new book takes you on the sets of recent films like *Star Wars*, *Flash Gordon*, *ALIEN*, *The Empire Strikes Back*, *Altered States*, *The Black Hole*, TV's *Dr. Who*, *Cosmos*, and more! Discover the innerworkings of Doug Trumbull's new ShowScan process and the new double-70mm 3-D system. If you are interested in filmmaking, here, in one volume, is your chance to learn about present-day techniques in special effects—and also glimpse what the future holds.

### SFX SECRETS

#### SPECIAL EFFECTS, Vol. 1

See the amazing world of miniatures and model animation—from *King Kong* to Ray Harryhausen and TV's *Land Of The Lost*. Special blueprint section includes: the Nautilus from *20,000 Leagues Under The Sea*, Robby the Robot, the C-57D flying saucer from *Forbidden Planet*. Behind-the-scenes color photos from *Battlestar: Galactica*, *Space: 1999*, *The Lost Saucer* and SF classics like *Close Encounters*, *Flight To Mars*, *Thunderbirds*, *War of the Worlds*, *Star Trek* . . . more!

#### SPECIAL EFFECTS, Vol. 2

Exclusive interviews with masters of matte painting, effects, make-up and cel animation. A festival of effects films from space epics to splatter movies—pictured in color photos and technical diagrams. Special section on making the giant squid from Disney's *20,000 Leagues Under The Sea*, the Time Machine from George Pal's movie, and the Enterprise designs—from TV to theatrical. All this . . . plus more!

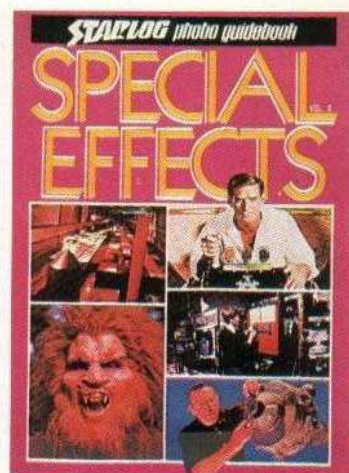
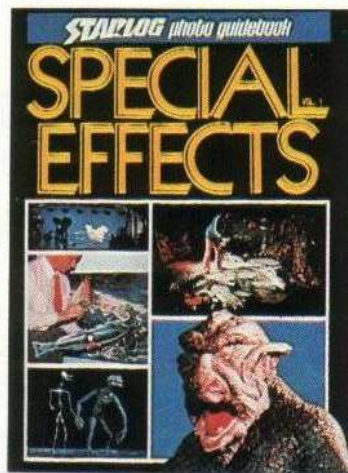

Add postage to your order:

Send to:  
STARLOG GUIDEBOOKS  
475 Park Avenue South  
New York, NY 10016

total enclosed: \$ \_\_\_\_\_  
NYS residents add sales tax  
Please allow 4 to 6 weeks for delivery of 3rd Class  
mail. First Class delivery usually takes 2 to 3 weeks.

Name \_\_\_\_\_  
Address \_\_\_\_\_  
City \_\_\_\_\_  
State \_\_\_\_\_ Zip \_\_\_\_\_

**SPECIAL EFFECTS**  
Vol. I ..... \$6.95  
Vol. II ..... \$7.95  
Vol. III ..... \$8.95  
Add Postage for Above:  
3rd Class ..... \$1.55 ea.  
1st Class ..... \$1.75 ea.  
Foreign Air ..... \$2.50 ea.

**ORDER NOW!**